

NACHI

AQUA DRILL EX FLAT

THE #1 SELLING FLAT BOTTOM DRILL

Metric & Fractional Sizes

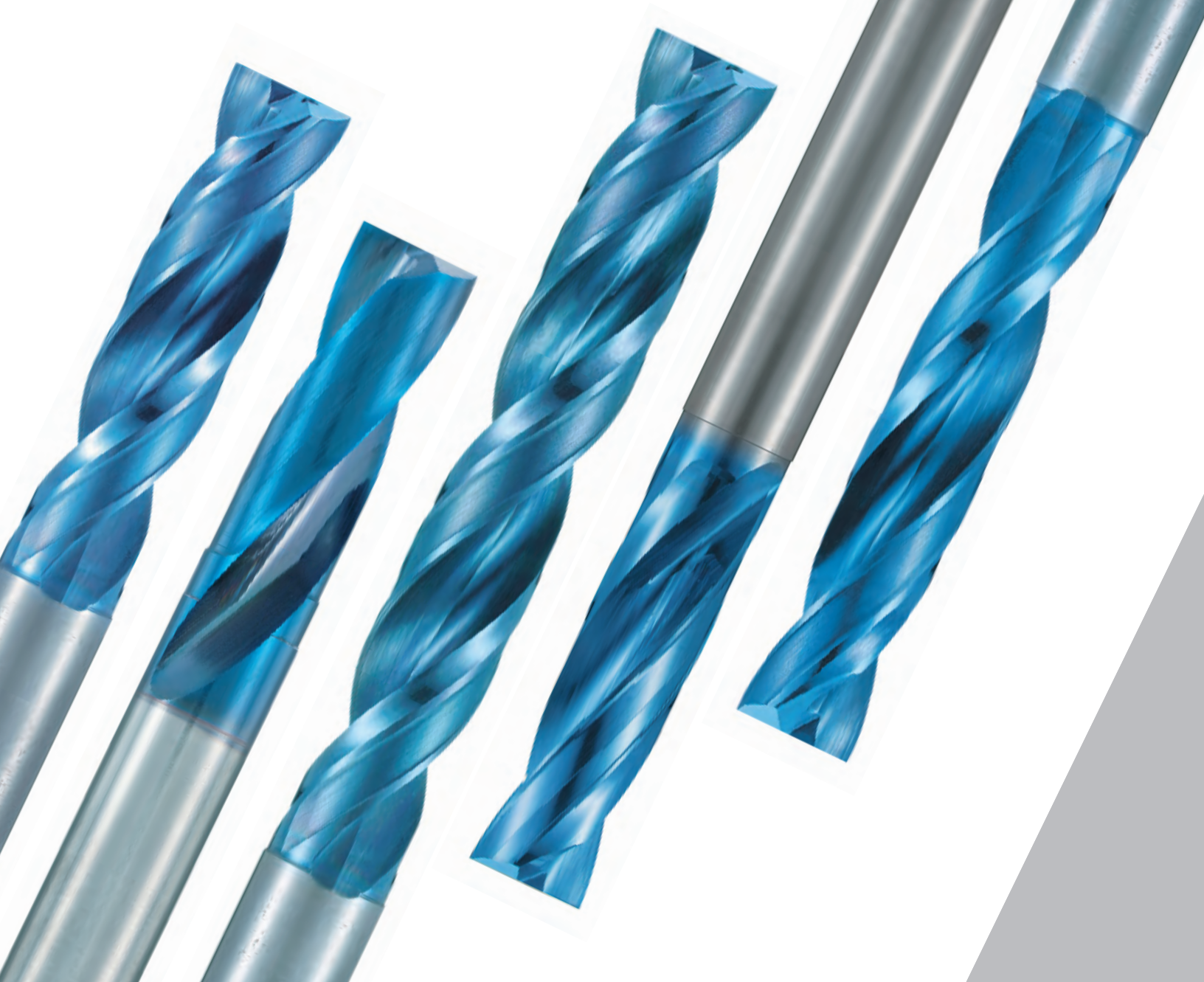

AQUA DRILL EX FLAT

- One Drill does it all - Eliminates the need to use a “center drill” or “end mill” on inclined or curved surfaces
- True 180° flat cutting edges creates minimal exit burr in Tubing & Thin Plates
- Ideally suited for flat bottom applications in the Oil and Gas, Automotive as well as General Industries
- “Double Margin” for stable and precision Drilling



AQUA DRILL EX FLAT

New Features:

New Features on 3D/5D/Extd. Length:

- 1) Double Margin
- 2) Corner Chamfer
- 3) Added Stability & Tool Life

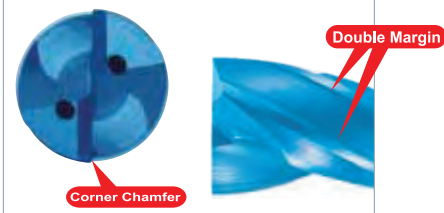

180° TRUE FLAT FACE

One cut to produce accurate counter bore surface

AQUA DRILL EX FLAT



Completely Flat Point

Endmill 2-Flute



Not a Flat Point

Cutting Resistance on 45° angled surface

Excellent Hole Drilling Performance

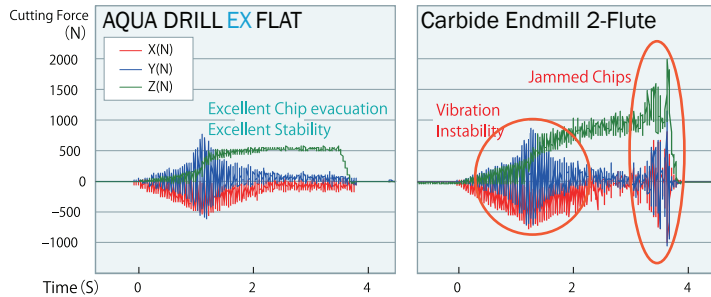

AQDEXZ 10.0 TEST DATA

Cutting conditions

Tool: AQDEXZ 10.0
 (SFM)RPM: (250)2400
 (IPR)IPM: (.002)6.0
 Material: Carbon Steel
 Coolant: Water Soluble

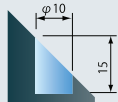

AQUA EX COATING

Improved Heat & Wear Resistance

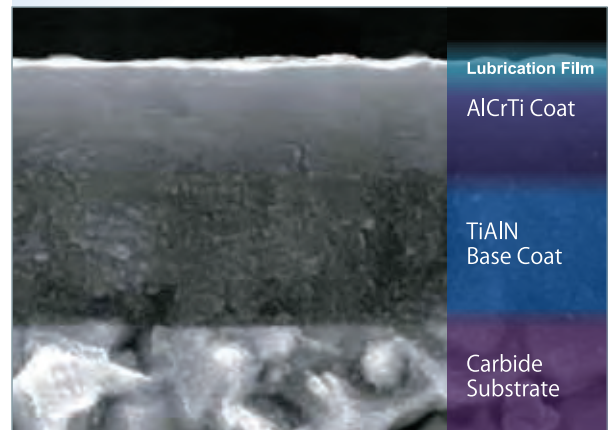

AQUA DRILL EX FLAT

Unique and Versatile High Performance Carbide Drill

One Step Drilling with Minimal Burr

Eliminate the need for “Center Drill” & “End mill”



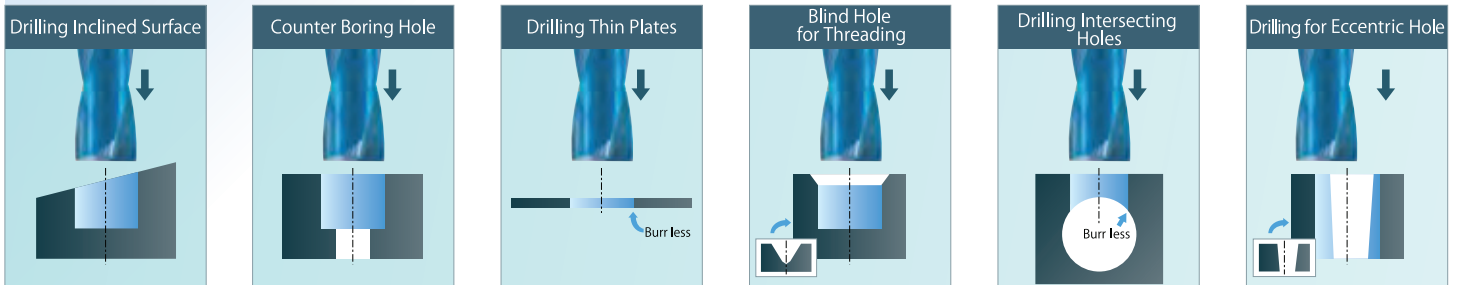



● Not recommended for milling ❌



New AQUA Drill EX Flat Series

“One Step Drilling with Minimal Burrs”

Aqua EX Flat Series Line Up

L9610, L9611 Non-Coolant Thru Stub Length Drill	
L9628 Non-Coolant Thru Super Stub Length Drill	
L9818, L9819 Non-Coolant Thru Jobber Length Drill	
L9816, L9817 Extended Length up to 10D Reach	
L9812, L9813 Coolant Thru 3D Flat Drill	
L9814, L9815 Coolant Thru 5D Flat Drill	
L9830, L9831 Ex Flat with Radius	

Diameter ϕ 1 ϕ 2 ϕ 3 ϕ 6 ϕ 10 ϕ 16 ϕ 20

List No.	Diameter	
	Metric	Fractional
L9610 L9611	0.2 - 20.0	1/8 - 3/4
L9628	2.0 - 20.0	
L9818 L9819	3.0 - 20.0	1/8 - 3/4
L9816 L9817	3.0 - 20.0	1/8 - 3/4
L9812 L9813	1.0 - 16.0	1/8 - 3/4
L9814 L9815	1.0 - 16.0	1/8 - 5/8
L9830 L9831	3.0 - 12.0	1/8 - 3/4

Aqua Drill EX Flat

Additional Applications

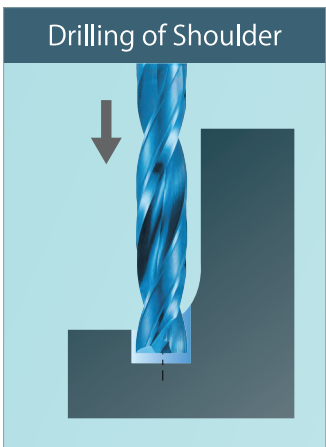
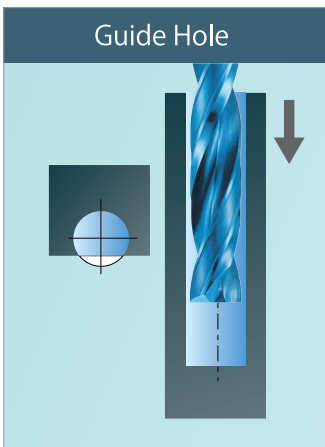
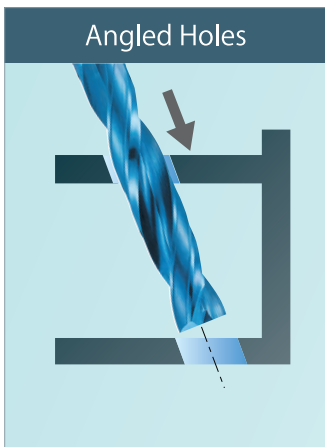
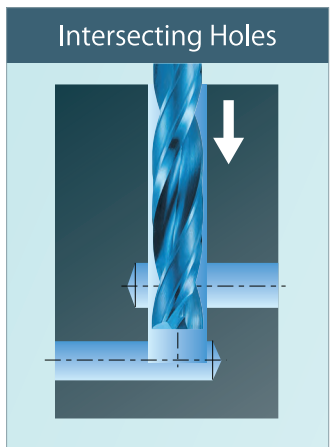
Drilling of Shoulder 	Guide Hole 	Angled Holes 	Intersecting Holes 
--	--	---	--

◎ = Great ○ = Good

Aqua EX Flat

Work Material	Applicable work materials											
	Structural Steels	Carbon Steels	Pre-Hardened Steels Alloy Steels	Hardened Steels Mold Steels	Hardened Steels		Stainless Steels		Titanium Alloys Nickel Alloys	Cast Irons	Aluminum Alloys	Copper Alloys
	SS400	S45C	SCM/NAK	30~40HRC	40~50HRC	50~60HRC	SUS304/SUS316	SUS420		FC/FCD	AC/ADC	CU
L9610, L9611 L9818, L9819 L9816, L9817	◎	◎	◎	◎	○			◎		◎	○	○
L9812, L9813 L9814, L9815	◎	◎	◎	◎	○		○	◎	○	◎	◎	◎

Aqua Drill EX Flat Stub



<1.9 mm, Dc x 2.3D

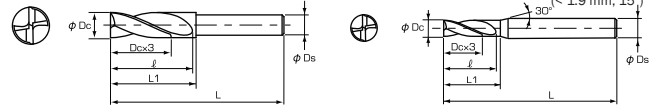

L9610 / L9611

Metric Size / Fractional Size

List #	EDP #	Size	Decimal Equivalent	Flute Length	Overall Length	L1	Shank Dia.	Stock
		Dc		ℓ	L	L1	Ds	
L9610	0751974	0.2	0.0079	0.66	47	0.98	3	•
L9610	0751968	0.3	0.0188	0.99		1.36		•
L9610	0751951	0.4	0.0157	1.32		1.65		•
L9610	0737198	0.5	0.0197	1.65		2.03		•
L9610	0737181	0.6	0.0236	1.98		2.32		•
L9610	0737175	0.7	0.0276	2.31		2.71		•
L9610	0737169	0.8	0.0315	2.64		2.99		•
L9610	0737152	0.9	0.0354	2.97		3.28		•
L9610	0715148	1.0	0.0394	3.3		3.6		•
L9610	0715154	1.1	0.0433	3.5		3.9		•
L9610	0715160	1.2	0.0472	3.9	4.2	•		
L9610	0715177	1.3	0.0512	4.2	4.5	•		
L9610	0715183	1.4	0.0551	4.6	4.9	•		
L9610	0715190	1.5	0.0591	4.9	5.2	•		
L9610	0715205	1.6	0.0630	5.2	5.5	•		
L9610	0715211	1.7	0.0669	5.5	5.8	•		
L9610	0715228	1.8	0.0709	5.8	6.1	•		
L9610	0715234	1.9	0.0748	6.2	6.5	•		
L9610	0711354	2.0	0.0787	9	9.8	4	•	
L9610	0713180	2.1	0.0827	11	11.4		•	
L9610	0711360	2.2	0.0866	11	11.4		•	
L9610	0713197	2.3	0.0906	11	11.5		•	
L9610	0713202	2.4	0.0945	12	12.6		•	
L9610	0711377	2.5	0.0984	12	12.7		•	
L9610	0713219	2.6	0.1024	12	12.8		•	
L9610	0713225	2.7	0.1063	14	14.9		•	
L9610	0713231	2.8	0.1102	14	15.0		•	
L9610	0713248	2.9	0.1142	14	15.0		•	
L9610	0709920	3.0	0.1181	15	14.4	6	•	
L9610	0713254	3.1	0.1220	15	15.5		•	
L9611	1455595	1/8	0.1250	15	18		•	
L9610	0713260	3.2	0.1260	15	15.6		•	
L9610	0710839	3.3	0.1299	16	15.7		•	
L9610	0713277	3.4	0.1339	16	16.2		•	
L9610	0709936	3.5	0.1378	16	16.3		•	
L9610	0713283	3.6	0.1417	18	16.4		•	
L9610	0713290	3.7	0.1457	18	18.0		•	
L9610	0713305	3.8	0.1496	18	18.1		•	
L9610	0713311	3.9	0.1535	18	18.2	•		
L9611	1455600	5/32	0.1563	19	20	60	•	
L9610	0709942	4.0	0.1575	19	18.3		•	
L9610	0713328	4.1	0.1614	19	20.4		•	
L9610	0710845	4.2	0.1654	19	20.4		•	
L9610	0713334	4.3	0.1693	21	20.5		•	
L9610	0713340	4.4	0.1732	21	22.6		•	
L9610	0709959	4.5	0.1772	21	22.7		•	
L9610	0713357	4.6	0.1811	21	22.8		•	
L9610	0713363	4.7	0.1850	22	22.9		•	
L9611	1455617	3/16	0.1875	22	24		•	
L9610	0713370	4.8	0.1890	22	23.0	6	•	
L9610	0713386	4.9	0.1929	23	23.0		•	
L9610	0709965	5.0	0.1969	23	23.1		•	
L9610	0713392	5.1	0.2008	24	26.2		•	
L9610	0713408	5.2	0.2047	24	26.3		•	
L9610	0711390	5.3	0.2087	24	26.4		•	
L9610	0713414	5.4	0.2126	25	27.5		•	
L9610	0709971	5.5	0.2165	25	27.6		•	
L9611	1455623	7/32	0.2188	25	28		•	
L9610	0713420	5.6	0.2205	27	27.7		•	
L9610	0713437	5.7	0.2244	27	29.7	•		
L9610	0713443	5.8	0.2283	27	29.8	•		
L9610	0713450	5.9	0.2323	27	29.9	•		
L9610	0709988	6.0	0.2362	30	30	•		

List #	EDP #	Size	Decimal Equivalent	Flute Length	Overall Length	L1	Shank Dia.	Stock
		Dc		ℓ	L	L1	Ds	
L9610	0713466	6.1	0.2402	28	70	31	6	•
L9610	0713472	6.2	0.2441					•
L9610	0713489	6.3	0.2480					•
L9611	1455630	1/4	0.2500					•
L9610	0713495	6.4	0.2520					•
L9610	0709994	6.5	0.2559					•
L9610	0713500	6.6	0.2598					•
L9610	0713517	6.7	0.2638					•
L9610	0710851	6.8	0.2677					•
L9610	0713523	6.9	0.2717					•
L9610	0710008	7.0	0.2756	30	33	6	•	
L9610	0713530	7.1	0.2795				•	
L9611	1455646	9/32	0.2812				•	
L9610	0713546	7.2	0.2835				•	
L9610	0713552	7.3	0.2874				•	
L9610	0713569	7.4	0.2913				•	
L9610	0710014	7.5	0.2953				•	
L9610	0713575	7.6	0.2992				•	
L9610	0713581	7.7	0.3031				•	
L9610	0713598	7.8	0.3071				•	
L9610	0713603	7.9	0.3110	36	36	8	•	
L9611	1455652	5/16	0.3125				•	
L9610	0710020	8.0	0.3150				•	
L9610	0713610	8.1	0.3189				•	
L9610	0713626	8.2	0.3228				•	
L9610	0713632	8.3	0.3268				•	
L9611	1455669	21/64	0.3281				•	
L9610	0713649	8.4	0.3307				•	
L9610	0710037	8.5	0.3346				•	
L9610	0713655	8.6	0.3386				•	
L9610	0713661	8.7	0.3425	37	40	8	•	
L9610	0711405	8.8	0.3465				•	
L9610	0713678	8.9	0.3504				•	
L9610	0710043	9.0	0.3543				•	
L9610	0713684	9.1	0.3583				•	
L9611	1455675	23/64	0.3594				•	
L9610	0713690	9.2	0.3622				•	
L9610	0713706	9.3	0.3661				•	
L9610	0713712	9.4	0.3701				•	
L9610	0710050	9.5	0.3740				•	
L9611	1455681	3/8	0.3750	39	42	8	•	
L9610	0713729	9.6	0.3780				•	
L9610	0713735	9.7	0.3819				•	
L9610	0713741	9.8	0.3858				•	
L9610	0713758	9.9	0.3898				•	
L9610	0710066	10.0	0.3937				•	
L9610	0713764	10.1	0.3976				•	
L9610	0713770	10.2	0.4016				•	
L9610	0710868	10.3	0.4055				•	
L9611	1455698	13/32	0.4063				•	
L9610	0713787	10.4	0.4094	40	45	10	•	
L9610	0710072	10.5	0.4134				•	
L9610	0713793	10.6	0.4173				•	
L9610	0711411	10.8	0.4252				•	
L9610	0713815	10.9	0.4291				•	
L9610	0710089	11.0	0.4331				•	
L9610	0713821	11.1	0.4370				•	
L9611	1455703	7/16	0.4375				•	
L9610	0713838	11.2	0.4409				•	
L9610	0713844	11.3	0.4449				•	
L9610	0713850	11.4	0.4488	48	51	10	•	
L9610	0710095	11.5	0.4528				•	

* Package Qty: 1 per Tube Size

L9610 / L9611

Metric Size / Fractional Size

List #	EDP #	Size	Decimal Equivalent	Flute Length	Overall Length	L1	Shank Dia. Ds	Stock
				ℓ	L	L1		
L9611	1455710	29/64	0.4531	52	90	54	10	•
L9610	0713867	11.6	0.4567	54		57		60
L9610	0713873	11.7	0.4606		57		60	
L9610	0713880	11.8	0.4646	57		60		•
L9610	0713896	11.9	0.4685		57		60	•
L9611	1455726	15/32	0.4688	57		60		60
L9610	0710100	12.0	0.4724		57		60	
L9610	0724619	12.1	0.4764	57		60		60
L9610	0724625	12.2	0.4803		57		60	
L9610	0724631	12.3	0.4843	57		60		60
L9610	0724648	12.4	0.4882		57		60	
L9610	0710117	12.5	0.4921	57		60		60
L9610	0724654	12.6	0.4961		57		60	
L9610	0724660	12.7	0.5000	57		60		60
L9611	1455732	1/2	0.5000		57		60	
L9610	0724677	12.8	0.5039	57		60		60
L9610	0724683	12.9	0.5079		57		60	
L9610	0710123	13.0	0.5118	57		60		60
L9610	0724690	13.1	0.5157		57		60	
L9610	0724705	13.2	0.5197	57		60		60
L9610	0724711	13.3	0.5236		57		60	
L9610	0724728	13.4	0.5276	57		60		60
L9610	0710130	13.5	0.5315		57		60	
L9610	0724734	13.6	0.5354	57		60		60
L9610	0724740	13.7	0.5394		57		60	
L9610	0724757	13.8	0.5433	57		60		60
L9610	0724763	13.9	0.5472		57		60	
L9610	0710146	14.0	0.5512	57		60		60
L9610	0724770	14.1	0.5551		57		60	
L9610	0724786	14.2	0.5591	57		60		60
L9611	1455749	9/16	0.5625		57		60	
L9610	0724792	14.3	0.5630	57		60		60
L9610	0724808	14.4	0.5669		57		60	
L9610	0710152	14.5	0.5709	57		60		60
L9610	0724814	14.6	0.5748		57		60	
L9610	0724820	14.7	0.5787	57		60		60
L9610	0724837	14.8	0.5827		57		60	
L9610	0724843	14.9	0.5866	57		60		60
L9610	0710169	15.0	0.5906		57		60	
L9610	0724850	15.1	0.5945	57		60		60
L9610	0724866	15.2	0.5984		57		60	
L9610	0724872	15.3	0.6024	57		60		60
L9610	0724889	15.4	0.6063		57		60	
L9610	0710175	15.5	0.6102	57		60		60
L9610	0724895	15.6	0.6142		57		60	
L9610	0724900	15.7	0.6181	57		60		60
L9610	0724917	15.8	0.6220		57		60	
L9611	1455755	5/8	0.6250	57		60		60
L9610	0724923	15.9	0.6260		57		60	
L9610	0710181	16.0	0.6299	57		60		60
L9610	0710198	16.5	0.6496		57		60	
L9610	0710203	17.0	0.6693	57		60		60
L9611	1455761	11/16	0.6875		57		60	
L9610	0710210	17.5	0.6890	57		60		60
L9610	0710226	18.0	0.7087		57		60	
L9610	0710232	18.5	0.7283	57		60		60
L9610	0710249	19.0	0.7480		57		60	
L9611	1455778	3/4	0.7500	57		60		60
L9610	0710255	19.5	0.7677		57		60	
L9610	0710261	20.0	0.7874	57		60		60

⚠ WARNING: Cancer - www.P65Warnings.ca.gov

Custom Orders Available

Designed specifically
for your application

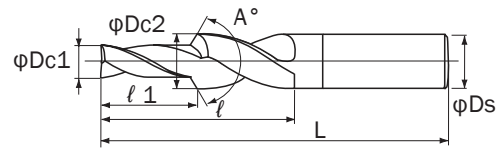

Special length, diameter,
step drill, deep hole

Available for all
Flat Bottom Carbide Drills

Contact Nachi Engineering at
toolsengineer@nachi-america.com

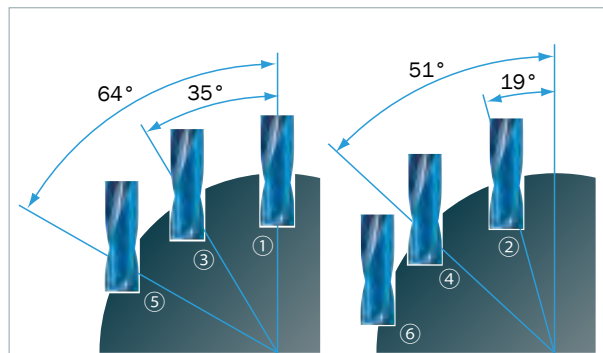

Aqua Drill EX Flat Radius

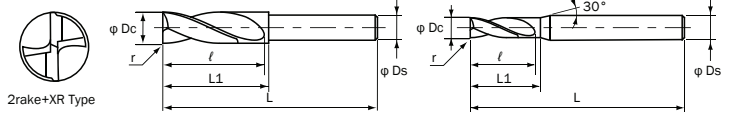
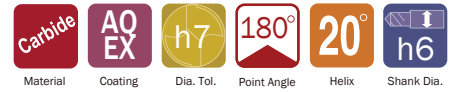
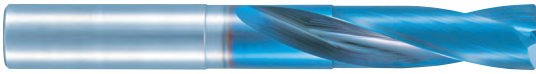

L9830 / L9831

Metric Size / Fractional Size

List No.	EDP NO.	Size	Decimal Equivalent	Radius	FL	OAL	L1	Shank Dia.	Stock	
		Dc		r	ℓ	L	L1	Ds		
9830	0732580	3.0	0.1181	0.3	14	50	16	6	•	
9830	1490158	3.1	0.1220		15		17		•	
9831	1489960	1/8	0.1250		15		17		•	
9830	1490164	3.2	0.1260		15		17		•	
9830	0732597	3.3	0.1299		15		17		•	
9830	1490170	3.4	0.1339		15		17		•	
9830	0732602	3.5	0.1378		16		18		•	
9830	1490187	3.6	0.1417		16		18		•	
9830	1490193	3.7	0.1457		16		18		•	
9830	1490209	3.8	0.1496		16		18		•	
9830	1490215	3.9	0.1535		18		20		•	
9831	1489977	5/32	0.1563		18		20		•	
9830	0732619	4.0	0.1575		18		20		•	
9830	1490221	4.1	0.1614		18		20		•	
9830	0732625	4.2	0.1654	19	21	•				
9830	1490238	4.3	0.1693	0.4	60	25	6	•		
9830	1490244	4.4	0.1732					21	23	•
9830	0732631	4.5	0.1772					21	23	•
9830	1490250	4.6	0.1811					21	23	•
9830	1490267	4.7	0.1850					21	23	•
9831	1489983	3/16	0.1875					21	23	•
9830	1490273	4.8	0.1890					22	24	•
9830	1490280	4.9	0.1929					22	24	•
9830	0732648	5.0	0.1969					23	25	•
9830	1490296	5.1	0.2008					23	25	•
9830	1490301	5.2	0.2047					24	26	•
9830	0732654	5.3	0.2087					24	26	•
9830	1490318	5.4	0.2126					24	26	•
9830	0732660	5.5	0.2165					25	27	•
9831	1489990	7/32	0.2188	25	27	•				
9830	1490324	5.6	0.2205	25	27	•				
9830	1490330	5.7	0.2244	27	29	•				
9830	1490347	5.8	0.2283	27	29	•				
9830	1490353	5.9	0.2323	27	29	•				
9830	0732677	6.0	0.2362	0.4	70	30	6	•		
9830	1490360	6.1	0.2402					28	30	•
9830	1490376	6.2	0.2441					28	30	•
9830	1490382	6.3	0.2480					28	30	•
9831	1490003	1/4	0.2500					30	31	•
9830	1490399	6.4	0.2520					30	31	•
9830	0732683	6.5	0.2559					30	31	•
9830	1490404	6.6	0.2598					30	31	•
9830	1490410	6.7	0.2638					30	31	•
9830	0732690	6.8	0.2677					31	33	•
9830	1490427	6.9	0.2717					31	33	•
9830	0732705	7.0	0.2756					32	33	•
9830	1490433	7.1	0.2795					32	33	•
9831	1490010	9/32	0.2812					33	36	•
9830	1490440	7.2	0.2835	33	36	•				
9830	1490456	7.3	0.2874	33	36	•				
9830	1490462	7.4	0.2913	33	36	•				
9830	0732711	7.5	0.2953	34	39	•				
9830	1490479	7.6	0.2992	34	39	•				
9830	1490485	7.7	0.3031	34	39	•				
9830	1490491	7.8	0.3071	36	39	•				

List No.	EDP NO.	Size	Decimal Equivalent	Radius	FL	OAL	L1	Shank Dia.	Stock		
		Dc		r	ℓ	L	L1	Ds			
9830	1490507	7.9	0.3110	0.4	36	70	39	6	•		
9831	1490026	5/16	0.3125						37	40	•
9830	0732728	8.0	0.3150						37	40	•
9830	1490513	8.1	0.3189						37	40	•
9830	1490520	8.2	0.3228						37	40	•
9830	1490536	8.3	0.3268						37	40	•
9831	1490032	21/64	0.3281						39	42	•
9830	1490542	8.4	0.3307						39	42	•
9830	0732734	8.5	0.3346						39	42	•
9830	1490559	8.6	0.3386						39	42	•
9830	1490565	8.7	0.3425						40	42	•
9830	0732740	8.8	0.3465						40	42	•
9830	1490571	8.9	0.3504						40	42	•
9830	0732757	9.0	0.3543						41	44	8
9830	1490588	9.1	0.3583	0.5	80	48	10	•			
9831	1490049	23/64	0.3594					42	44	•	
9830	1490594	9.2	0.3622					42	44	•	
9830	1490600	9.3	0.3661					42	44	•	
9830	1490616	9.4	0.3701					42	44	•	
9830	0732763	9.5	0.3740					43	45	•	
9831	1490055	3/8	0.3750					43	45	•	
9830	1490622	9.6	0.3780					43	45	•	
9830	1490639	9.7	0.3819					43	45	•	
9830	1490645	9.8	0.3858					43	45	•	
9830	1490651	9.9	0.3898					43	45	•	
9830	0732770	10.0	0.3937					45	48	•	
9830	1490668	10.1	0.3976					45	48	•	
9830	1490674	10.2	0.4016					45	48	•	
9830	0732786	10.3	0.4055	46	49	•					
9831	1490061	13/32	0.4063	46	49	•					
9830	1490680	10.4	0.4094	46	49	•					
9830	0732792	10.5	0.4134	48	51	•					
9830	1490697	10.6	0.4173	48	51	•					
9830	1490702	10.7	0.4213	48	51	•					
9830	0732808	10.8	0.4252	49	51	•					
9830	1490719	10.9	0.4291	49	51	•					
9830	0732814	11.0	0.4331	49	51	•					
9830	1490725	11.1	0.4370	50	54	10	•				
9831	1490078	7/16	0.4375	50	54	•					
9830	1490731	11.2	0.4409	51	54	•					
9830	1490748	11.3	0.4449	51	54	•					
9830	1490754	11.4	0.4488	51	54	•					
9830	0732820	11.5	0.4528	51	54	•					
9831	1490084	29/64	0.4531	52	57	•					
9830	1490760	11.6	0.4567	52	57	•					
9830	1490777	11.7	0.4606	52	57	•					
9830	1490783	11.8	0.4646	52	57	•					
9830	1490790	11.9	0.4685	54	57	•					
9831	1490090	15/32	0.4688	54	57	•					
9830	0732837	12.0	0.4724	54	57	•					
9831	1490106	1/2	0.5000	58	100	60	12	•			
9831	1490112	9/16	0.5625	64	105	67	•				
9831	1490129	5/8	0.6250	72	115	75	•				
9831	1490135	11/16	0.6875	79	125	81	•				
9831	1490141	3/4	0.7500	87	135	90	16	•			

Aqua Drill EX Flat Jobber Length



• For entry on flat surfaces, Center Drill Hole is recommended

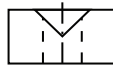

• Center Hole Diameter should be 0.5mm larger than Flat drill Diameter

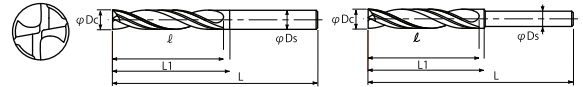

L9818 / L9819

Metric Size / Fractional Size

List #	EDP #	Size	Decimal Equivalent	Flute Length ℓ	Overall Length L	L1	Shank Dia. Ds	Stock														
L9818	0720751	3.0	0.1181	19	60	20	6	•														
L9818	0720768	3.1	0.1220	21		23		•														
L9819	1489249	1/8	0.1250			23		24	•													
L9818	0720774	3.2	0.1260					25	25	•												
L9818	0720780	3.3	0.1299							•												
L9818	0720797	3.4	0.1339							•												
L9818	0720802	3.5	0.1378							•												
L9818	0720819	3.6	0.1417							•												
L9818	0720825	3.7	0.1457							•												
L9818	0720831	3.8	0.1496							27	29	•										
L9818	0720848	3.9	0.1535		25		30					•										
L9819	1489255	5/32	0.1563	29								32	•									
L9818	0720854	4.0	0.1575			31							33	•								
L9818	0720860	4.1	0.1614					32	32					•								
L9818	0720877	4.2	0.1654											34	36	•						
L9818	0720883	4.3	0.1693													36	37	•				
L9818	0720890	4.4	0.1732															40	41	•		
L9818	0720905	4.5	0.1772																	38	39	•
L9818	0720911	4.6	0.1811																			42
L9818	0720928	4.7	0.1850							70	45											
L9819	1489261	3/16	0.1875		44		45															
L9818	0720934	4.8	0.1890	46								47										
L9818	0720940	4.9	0.1929			90							49									
L9818	0720957	5.0	0.1969					48	49													
L9818	0720963	5.1	0.2008											51	52							
L9818	0720970	5.2	0.2047													52	53					
L9818	0720986	5.3	0.2087															100	53			
L9818	0720992	5.4	0.2126																	54	55	
L9818	0721007	5.5	0.2165																			85
L9819	1489278	7/32	0.2188							70	45											
L9818	0721013	5.6	0.2205		42		43															
L9818	0721020	5.7	0.2244	44								45										
L9818	0721036	5.8	0.2283			46							47									
L9818	0721042	5.9	0.2323					90	49													
L9818	0721059	6.0	0.2362											48	49							
L9818	0721065	6.1	0.2402													51	52					
L9818	0721071	6.2	0.2441															52	53			
L9818	0721088	6.3	0.2480																	100	53	
L9819	1489284	1/4	0.2500																			54
L9818	0721094	6.4	0.2520							42	43											
L9818	0721100	6.5	0.2559		44		45															
L9818	0721116	6.6	0.2598	46								47										
L9818	0721122	6.7	0.2638			90							49									
L9818	0721139	6.8	0.2677					48	49													
L9818	0721145	6.9	0.2717											51	52							
L9818	0721151	7.0	0.2756													52	53					
L9818	0721168	7.1	0.2795															100	53			
L9819	1489290	9/32	0.2812																	46	47	
L9818	0721174	7.2	0.2835																			48
L9818	0721180	7.3	0.2874							51	52											
L9818	0721197	7.4	0.2913		52		53															
L9818	0721202	7.5	0.2953	54								55										
L9818	0721219	7.6	0.2992			85							43									
L9818	0721225	7.7	0.3031					70	45													
L9818	0721231	7.8	0.3071											42	43							
L9818	0721248	7.9	0.3110													44	45					
L9819	1489306	5/16	0.3125															46	47			
L9818	0721254	8.0	0.3150																	90	49	
L9818	0721260	8.1	0.3189																			48
L9818	0721277	8.2	0.3228							51	52											
L9818	0721283	8.3	0.3268		52		53															
L9819	1489312	21/64	0.3281	100								53										
L9818	0721290	8.4	0.3307			54							55									

List #	EDP #	Size	Decimal Equivalent	Flute Length ℓ	Overall Length L	L1	Shank Dia. Ds	Stock																
L9818	0721305	8.5	0.3346	54	100	55	8	•																
L9818	0721311	8.6	0.3386					56	57	•														
L9818	0721328	8.7	0.3425							58	59	•												
L9818	0721334	8.8	0.3465									59	60	•										
L9818	0721340	8.9	0.3504											61	62	•								
L9818	0721357	9.0	0.3543													63	64	•						
L9818	0721363	9.1	0.3583															65	66	•				
L9819	1489329	23/64	0.3594																	67	68	•		
L9818	0721370	9.2	0.3622																			69	70	•
L9818	0721386	9.3	0.3661																					71
L9818	0721392	9.4	0.3701	73	74	•																		
L9818	0721408	9.5	0.3740			76	77	•																
L9819	1489335	3/8	0.3750					80	125	•														
L9818	0721414	9.6	0.3780							81	83	•												
L9818	0721420	9.7	0.3819									82	83	•										
L9818	0721437	9.8	0.3858											83	87	•								
L9818	0721443	9.9	0.3898													84	89	•						
L9818	0721450	10.0	0.3937															85	91	•				
L9818	0721466	10.1	0.3976																	86	93	•		
L9818	0721472	10.2	0.4016																			87	96	•
L9818	0721489	10.3	0.4055	88	99																			•
L9819	1489341	13/32	0.4063			89	102																	•
L9818	0721495	10.4	0.4094					90	104															•
L9818	0721500	10.5	0.4134							91	106													•
L9818	0721517	10.6	0.4173									92	109											•
L9818	0721523	10.7	0.4213											93	112									•
L9818	0721530	10.8	0.4252													94	114							•
L9818	0721546	10.9	0.4291															95	119					•
L9818	0721552	11.0	0.4331																	96	121			•
L9818	0721569	11.1	0.4370																			97	125	•
L9819	1489358	7/16	0.4375	98	129																			•
L9818	0721575	11.2	0.4409			99	135																	•
L9818	0721581	11.3	0.4449					100	145															•
L9818	0721598	11.4	0.4488							101	160													•
L9818	0721603	11.5	0.4528									102	175											•
L9819	1489364	29/64	0.4531											103	185									•
L9818	0721610	11.6	0.4567													104	195							•
L9818	0721626	11.7	0.4606															105	129					•
L9818	0721632	11.8	0.4646																	106	129			•
L9818	0721649	11.9	0.4685																			107	129	•
L9819	1489370	15/32	0.4688	108	129																			•
L9818	0721655	12.0	0.4724			109	129																	•
L9818	0721661	12.5	0.4921					110	129															•
L9819	1489387	1/2	0.5000							111	129													•
L9818	0721678	13.0	0.5118									112	129											•
L9818	0721684	13.5	0.5315											113	129									•
L9818	0721690	14.0	0.5512													114	129							•
L9819	1489393	9/16	0.5625															115	129					•
L9818	0721706	14.5	0.5709																	116	129			•
L9818	0721712	15.0	0.5906																			117	129	•
L9818	0721729	15.5	0.6102	118	129																			•
L9819	1489409	5/8	0.6250			119	129																	•
L9818	0721735	16.0	0.6299					120	129															•
L9818	0721741	16.5	0.6496							121	129													•
L9818	0721758	17.0	0.6693									122	129											•
L9819	1489415	11/16	0.6875											123	129									•
L9818	0721764	17.5	0.6890													124	129							•
L9818	0721770	18.0	0.7087															125	129					•
L9818	0721787	18.5	0.7283																	126	129			•
L9818	0721793	19.0	0.7480																			127	129	•
L9819	1489421	3/4	0.7500	128	129																			•
L9818	0721809	19.5	0.7677			129	129																	•
L9818	0721815	20.0	0.7874					129	129															•

* Package Qty: 1 per Tube Size

WARNING: Cancer - www.P65Warnings.ca.gov

Aqua Drill EX Flat Long Shank



• For entry on flat surfaces,
Center Drill Hole is
recommended

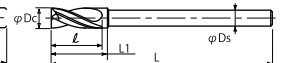
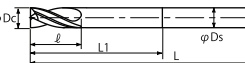

• Center Hole Diameter
should be 0.5mm larger
than Flat Drill Diameter

L9816 / L9817

Metric Size / Fractional Size

List #	EDP #	Size	Decimal Equivalent	Flute Length	Overall Length	L1	Shank Dia.	Stock
L9816	0717701	3.0	0.1181	14	100	30	6	•
L9816	0717718	3.1	0.1220	15		31		•
L9817	1489438	1/8	0.1250			32		•
L9816	0717724	3.2	0.1260	16		32		•
L9816	0717730	3.3	0.1299			33		•
L9816	0717747	3.4	0.1339	18		34		•
L9816	0717753	3.5	0.1378			35		•
L9816	0717760	3.6	0.1417	19		36		•
L9816	0717776	3.7	0.1457			37		•
L9816	0717782	3.8	0.1496	21		38		•
L9816	0717799	3.9	0.1535		39	•		
L9817	1489444	5/32	0.1563	22	40	•		
L9816	0717804	4.0	0.1575		40	•		
L9816	0717810	4.1	0.1614	23	41	•		
L9816	0717827	4.2	0.1654		42	•		
L9816	0717833	4.3	0.1693	24	43	•		
L9816	0717840	4.4	0.1732		44	•		
L9816	0717856	4.5	0.1772	25	45	•		
L9816	0717862	4.6	0.1811		46	•		
L9816	0717879	4.7	0.1850	27	47	•		
L9817	1489450	3/16	0.1875		48	•		
L9816	0717885	4.8	0.1890	28	48	•		
L9816	0717891	4.9	0.1929		49	•		
L9816	0717907	5.0	0.1969	30	50	•		
L9816	0717913	5.1	0.2008		51	•		
L9816	0717920	5.2	0.2047	31	52	•		
L9816	0717936	5.3	0.2087		53	•		
L9816	0717942	5.4	0.2126	32	54	•		
L9816	0717959	5.5	0.2165		55	•		
L9817	1489467	7/32	0.2188	33	56	•		
L9816	0717965	5.6	0.2205		56	•		
L9816	0717971	5.7	0.2244	34	57	•		
L9816	0717988	5.8	0.2283		58	•		
L9816	0717994	5.9	0.2323	35	59	•		
L9816	0718009	6.0	0.2362		60	•		
L9816	0718015	6.1	0.2402	36	30	•		
L9816	0718021	6.2	0.2441			•		
L9816	0718038	6.3	0.2480	37	32	•		
L9817	1489473	1/4	0.2500			•		
L9816	0718044	6.4	0.2520	38	33	•		
L9816	0718050	6.5	0.2559			•		
L9816	0718067	6.6	0.2598	39	34	•		
L9816	0718073	6.7	0.2638			•		
L9816	0718080	6.8	0.2677	40	35	•		
L9816	0718096	6.9	0.2717			•		
L9816	0718101	7.0	0.2756	41	36	•		
L9816	0718118	7.1	0.2795			•		
L9817	1489480	9/32	0.2812	42	37	•		
L9816	0718124	7.2	0.2835			•		
L9816	0718130	7.3	0.2874	43	38	•		
L9816	0718147	7.4	0.2913			•		
L9816	0718153	7.5	0.2953	44	39	•		
L9816	0718160	7.6	0.2992			•		
L9816	0718176	7.7	0.3031	45	40	•		
L9816	0718182	7.8	0.3071			•		
L9816	0718199	7.9	0.3110	46	41	•		
L9817	1489496	5/16	0.3125			•		
L9816	0718204	8.0	0.3150	47	80	•		
L9816	0718210	8.1	0.3189			•		
L9816	0718227	8.2	0.3228	48	39	•		
L9816	0718233	8.3	0.3268			•		
L9817	1489501	21/64	0.3281	49	41	•		
L9816	0718240	8.4	0.3307			•		

List #	EDP #	Size	Decimal Equivalent	Flute Length	Overall Length	L1	Shank Dia.	Stock
L9816	0718256	8.5	0.3346	39	130	41	8	•
L9816	0718262	8.6	0.3386					•
L9816	0718279	8.7	0.3425	40	130	42	8	•
L9816	0718285	8.8	0.3465					•
L9816	0718291	8.9	0.3504	41	130	43	8	•
L9816	0718307	9.0	0.3543					•
L9816	0718313	9.1	0.3583	42	130	44	8	•
L9817	1489518	23/64	0.3594					•
L9816	0718320	9.2	0.3622	43	130	45	8	•
L9816	0718336	9.3	0.3661					•
L9816	0718342	9.4	0.3701	44	130	46	8	•
L9816	0718359	9.5	0.3740					•
L9817	1489524	3/8	0.3750	45	130	47	8	•
L9816	0718365	9.6	0.3780					•
L9816	0718371	9.7	0.3819	46	130	48	8	•
L9816	0718388	9.8	0.3858					•
L9816	0718394	9.9	0.3898	47	130	49	8	•
L9816	0718400	10.0	0.3937					•
L9816	0718416	10.1	0.3976	48	130	50	8	•
L9816	0718422	10.2	0.4016					•
L9816	0718439	10.3	0.4055	49	130	51	8	•
L9817	1489530	13/32	0.4063					•
L9816	0718445	10.4	0.4094	50	130	52	8	•
L9816	0718451	10.5	0.4134					•
L9816	0718468	10.6	0.4173	51	130	53	8	•
L9816	0718474	10.7	0.4213					•
L9816	0718480	10.8	0.4252	52	130	54	8	•
L9816	0718497	10.9	0.4291					•
L9816	0718502	11.0	0.4331	53	130	55	8	•
L9816	0718519	11.1	0.4370					•
L9817	1489547	7/16	0.4375	54	130	56	8	•
L9816	0718525	11.2	0.4409					•
L9816	0718531	11.3	0.4449	55	130	57	8	•
L9816	0718548	11.4	0.4488					•
L9816	0718554	11.5	0.4528	56	130	58	8	•
L9817	1489553	29/64	0.4531					•
L9816	0718560	11.6	0.4567	57	130	59	8	•
L9816	0718577	11.7	0.4606					•
L9816	0718583	11.8	0.4646	58	130	60	8	•
L9816	0718590	11.9	0.4685					•
L9817	1489560	15/32	0.4688	59	130	61	8	•
L9816	0718605	12.0	0.4724					•
L9816	0718611	12.5	0.4921	60	130	62	8	•
L9817	1489576	1/2	0.5000					•
L9816	0718628	13.0	0.5118	61	130	63	8	•
L9816	0718634	13.5	0.5315					•
L9816	0718640	14.0	0.5512	62	130	64	8	•
L9817	1489582	9/16	0.5625					•
L9816	0718657	14.5	0.5709	63	130	65	8	•
L9816	0718663	15.0	0.5906					•
L9816	0718670	15.5	0.6102	64	130	66	8	•
L9817	1489599	5/8	0.6250					•
L9816	0718686	16.0	0.6299	65	130	67	8	•
L9816	0718692	16.5	0.6496					•
L9816	0718708	17.0	0.6693	66	130	68	8	•
L9817	1489604	11/16	0.6875					•
L9816	0718714	17.5	0.6890	67	130	69	8	•
L9816	0718720	18.0	0.7087					•
L9816	0718737	18.5	0.7283	68	130	70	8	•
L9816	0718743	19.0	0.7480					•
L9817	1489610	3/4	0.7500	69	130	71	8	•
L9816	0718750	19.5	0.7677					•
L9816	0718766	20.0	0.7874	70	130	72	8	•

Aqua Drill EX Flat - Standard Drilling Conditions

LIST 9610, 9611, 9830, 9831

Work Material			Cast Irons / Carbon Steels		Alloy Steels (20-30 HRC)		Mold Steels/ (30-35 HRC)		Ductile Cast Irons		Stainless Steel (300 Series)		Aluminum Alloys		Aluminum Casting	
Speed (SFM)			65-230 SFM		60-200 SFM		35-120 SFM		60-200 SFM		125-500 SFM		125-500 SFM		120-350 SFM	
Metric	mm	Decimal	RPM	Feed (IPR)	RPM	Feed (IPR)	RPM	Feed (IPR)	RPM	Feed (IPR)	RPM	Feed (IPR)	RPM	Feed (IPR)	RPM	Feed (IPR)
0.2	0.007		32000	0.0001	29000	0.0001	14000	0.0001	29000	0.0001	16000	0.0001	32000	0.0002	32000	0.0001
0.5	0.019		25500	0.0001	21000	0.0001	10000	0.0001	21000	0.0001	12500	0.0002	29000	0.0004	25500	0.0033
1	0.039		19000	0.0006	15900	0.0006	6400	0.0003	15900	0.0005	9550	0.0004	24000	0.0012	19000	0.0008
1.5	0.059		25500	0.0001	21000	0.0001	10000	0.0001	21000	0.0001	7300	0.0007	29000	0.0004	25500	0.0033
2	0.078		12000	0.0009	11500	0.0009	3200	0.0007	11500	0.0009	5030	0.0014	21000	0.0016	14500	0.0013
Speed (SFM)			325-328 SFM		290-295 SFM		220-225 SFM		290-295 SFM		515-525 SFM		515-525 SFM		260-400 SFM	
3	0.118		7950	0.0020	6900	0.0020	3700	0.0020	6900	0.0015	2600	0.0020	17000	0.0025	12500	0.0020
4	0.157		5950	0.0025	5150	0.0025	2800	0.0025	5150	0.0025	1950	0.0023	12500	0.0030	9550	0.0025
5	0.197		4800	0.0035	4150	0.0035	2200	0.0030	4100	0.0030	1550	0.0026	10000	0.0040	7650	0.0035
6	0.236		4000	0.0040	3450	0.0040	1800	0.0035	3450	0.0035	1300	0.0031	8500	0.0045	6400	0.0040
8	0.315		3000	0.0055	2600	0.0055	1400	0.0050	2600	0.0045	970	0.0038	6350	0.0065	4750	0.0055
10	0.394		2400	0.0070	2050	0.0070	1100	0.0060	2050	0.0060	780	0.0047	5100	0.0080	3800	0.0070
12	0.472		2000	0.0085	1700	0.0085	950	0.0070	1700	0.0070	650	0.0057	4250	0.0095	3200	0.0080
16	0.630		1500	0.0110	1300	0.0110	700	0.0095	1300	0.0095	550	0.0063	3200	0.0125	2400	0.0110
20	0.787		1200	0.0140	1050	0.0135	550	0.0120	1050	0.0115	480	0.0066	2550	0.0155	1900	0.0135

- Note : 1) Adjust drilling conditions according to the rigidity of machine or work clamp state.
 2) Use the table values for drilling depths upto 2xD. Adjust cutting conditions per table based on "degree angle to be drilled."
 3) Above table values are for drilling water soluble cutting fluid. For non-water soluble cutting fluid reduce the RPM and feed rates by 20%
 4) Not recommended for drilling in Stainless Steel. We recommend using List9814 AQUA EX Flat OH3Dor OH5D for Stainless Steel & Hi-temp alloys.
 5) Center Drill or Guide hole required. (1: Use AG Starting drill or Aqua Ex Flat drill)

Formulas : $RPM = \frac{SFM \times 3.82}{\text{Drill dia.}}$ Feed Rate (in/min) : $RPM \times IPR$

Drilling Conditions for Angled Surfaces					
Reduction % to above table values					
Degree Angle		Reduction %		Reduction % (Multiplier)	
		RPM	Feed	RPM	Feed
0°	5°	100%	100%	Table Value	Table Value
6°	20°	50%	50%	(Table Value)x0.5	(Table Value)x0.5
21°	35°	70%	40%	(Table Value)x0.3	(Table Value)x0.6
36°	60°	70%	40%	(Table Value)x0.3	(Table Value)x0.6
61°		70%	30%	(Table Value)x0.3	(Table Value)x0.7

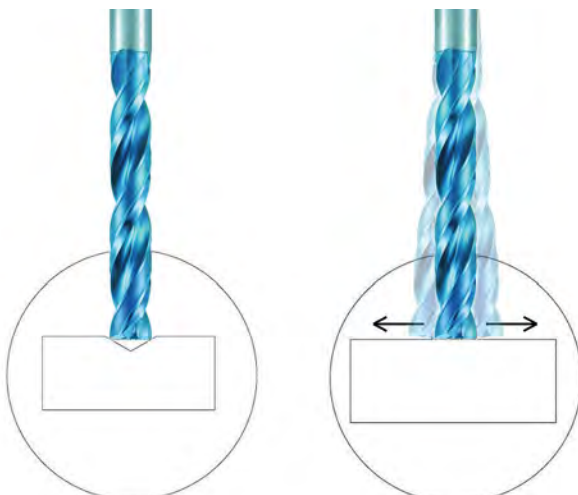

The longer a drill is, the higher the chance that it will walk. Flat bottom drills have a true 180° point. When entering on a flat surface, this amount of surface contact can cause the drill to walk. If this occurs, using a spot drill prior to the flat bottom drill will help to alleviate some of the surface contact to allow the drill to start properly.

Aqua Drill EX Flat - Standard Drilling Conditions

LIST 9818, 9819

Work Material			Cast Irons / Carbon Steels		Alloy Steels (20-30 HRC)		Mold Steels/ Hardened Steels (30-35 HRC)		Ductile Cast Irons		Aluminum Alloys		Aluminum Casting	
Speed (SFM)			325-328 SFM		290-295 SFM		220-225 SFM		290-295 SFM		515-525 SFM		260-400 SFM	
Drill Diameter			325-328 SFM		290-295 SFM		220-225 SFM		290-295 SFM		515-525 SFM		260-400 SFM	
Metric	mm	Decimal	RPM	Feed (IPR)	RPM	Feed (IPR)	RPM	Feed (IPR)	RPM	Feed (IPR)	RPM	Feed (IPR)	RPM	Feed (IPR)
3	0.118		10600	0.002	9500	0.002	7400	0.002	9500	0.002	17000	0.002	12700	0.002
4	0.157		7900	0.003	7100	0.002	5550	0.002	7100	0.002	12500	0.002	9500	0.003
5	0.197		6300	0.004	5700	0.003	4450	0.003	5700	0.003	10000	0.003	7600	0.004
6	0.236		5300	0.005	4750	0.004	3700	0.004	4750	0.004	8500	0.003	6400	0.005
8	0.315		3950	0.006	3550	0.005	2790	0.005	3550	0.005	6350	0.005	4780	0.006
10	0.394		3150	0.008	2860	0.006	2230	0.006	2860	0.006	5100	0.006	3800	0.008
12	0.472		2650	0.009	2390	0.007	1860	0.007	2390	0.007	4250	0.007	3180	0.009
16	0.630		1990	0.012	1790	0.009	1390	0.009	1790	0.009	3200	0.009	2390	0.013
20	0.787		1590	0.016	1430	0.012	1110	0.012	1430	0.012	2550	0.012	1910	0.016

LIST 9816, 9817

Work Material			Cast Irons / Carbon Steels		Alloy Steels (20-30 HRC)		Mold Steels/ Hardened Steels (30-35 HRC)		Ductile Cast Irons		Aluminum Alloys		Aluminum Casting	
Speed (SFM)			325-328 SFM		290-295 SFM		220-225 SFM		290-295 SFM		515-525 SFM		260-400 SFM	
Drill Diameter			325-328 SFM		290-295 SFM		220-225 SFM		290-295 SFM		515-525 SFM		260-400 SFM	
Metric	mm	Decimal	RPM	Feed (IPR)	RPM	Feed (IPR)	RPM	Feed (IPR)	RPM	Feed (IPR)	RPM	Feed (IPR)	RPM	Feed (IPR)
3	0.118		10600	0.003	9500	0.002	7400	0.002	9500	0.002	17000	0.002	12700	0.002
4	0.157		7900	0.004	7100	0.003	5550	0.002	7100	0.003	12500	0.002	9500	0.003
5	0.197		6300	0.005	5700	0.004	4450	0.003	5700	0.004	10000	0.003	7600	0.004
6	0.236		5300	0.006	4750	0.005	3700	0.004	4750	0.005	8500	0.003	6400	0.005
8	0.315		3950	0.008	3550	0.006	2790	0.005	3550	0.006	6350	0.005	4780	0.006
10	0.394		3150	0.010	2860	0.008	2230	0.006	2860	0.008	5100	0.006	3800	0.008
12	0.472		2650	0.012	2390	0.009	1860	0.007	2390	0.009	4250	0.007	3180	0.009
16	0.630		1990	0.016	1790	0.013	1390	0.009	1790	0.013	3200	0.009	2390	0.013
20	0.787		1590	0.020	1430	0.016	1110	0.012	1430	0.016	2550	0.012	1910	0.016

- Note :
- 1) Adjust drilling conditions according to the rigidity of machine or work clamp state.
 - 2) Use the table values for drilling depths upto 2xD. Adjust cutting conditions per table based on "degree angle to be drilled."
 - 3) Above table values are for drilling water soluble cutting fluid. For non-water soluble cutting fluid reduce the RPM and feed rates by 20%
 - 4) Not recommended for drilling in Stainless Steel. We recommend using List9814 AQUA EX Flat OH3Dor OH5D for Stainless Steel & Hi-temp alloys.
 - 5) Center Drill or Guide hole required. (1: Use AG Starting drill or Aqua Ex Flat drill)

Formulas : $RPM = \frac{SFM \times 3.82}{\text{Drill dia.}}$ Feed Rate (in/min) : RPM*IPR

Aqua Drill EX Flat Oil Hole 3D



L9812 / L9813

Metric Size / Fractional Size Including NEW MICRO Sizes!

Drill Dia (in mm)		Corner Chamfer
Above	Up to	C (mm)
	6.0	0.04
6.0	10.0	0.1
10.0		0.2

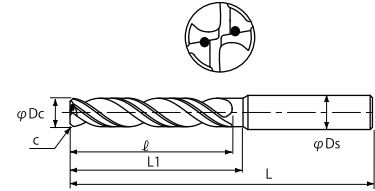

List #	EDP #	Size	Decimal Equivalent	Flute Length ℓ	Overall Length L	L1	Shank Dia. Ds	Stock	
L9812	0760322	1.0	0.0394	4.3	55	4.6	3	•	
L9812	0760339	1.1	0.0433	4.7	58	5		•	
L9812	0760345	1.2	0.0472	5.2		5.5		•	
L9812	0760351	1.3	0.0512	5.6		5.9		•	
L9812	0760368	1.4	0.0551	6		6.3		•	
L9812	0760374	1.5	0.0591	6.5		6.8		•	
L9812	0760380	1.6	0.0630	6.9		7.2		•	
L9812	0760397	1.7	0.0669	7.3		7.6		•	
L9812	0760402	1.8	0.0709	7.7		8		•	
L9812	0760419	1.9	0.0748	8.2		8.5		•	
L9812	0760425	2.0	0.0787	8.6		8.9		•	
L9812	0760431	2.1	0.0827	9		9.3		•	
L9812	0760448	2.2	0.0866	9.5		9.8		•	
L9812	0760454	2.3	0.0906	9.9		62		10.2	•
L9812	0760460	2.4	0.0945	10.3		10.6		•	
L9812	0760477	2.5	0.0984	10.8		11.1	•		
L9812	0760483	2.6	0.1024	11.2	11.5	•			
L9812	0760490	2.7	0.1063	11.6	68	11.9	•		
L9812	0760505	2.8	0.1102	12	12.3	•			
L9812	0760511	2.9	0.1142	12.5	12.9	•			
L9812	0718772	3.0	0.1181	14	68	15	•		
L9812	0718789	3.1	0.1220	15	72	17	4	•	
L9813	1489627	1/8	0.1250					•	
L9812	0718795	3.2	0.1260					•	
L9812	0718800	3.3	0.1299	16	18	19	5	•	
L9812	0718817	3.4	0.1339					•	
L9812	0718823	3.5	0.1378					•	
L9812	0718830	3.6	0.1417	18	22	23	6	•	
L9812	0718846	3.7	0.1457					•	
L9812	0718852	3.8	0.1496					•	
L9812	0718869	3.9	0.1535	19	24	25	7	•	
L9813	1489633	5/32	0.1563					•	
L9812	0718875	4.0	0.1575					•	
L9812	0718881	4.1	0.1614	21	26	27	8	•	
L9812	0718898	4.2	0.1654					•	
L9812	0718903	4.3	0.1693					•	
L9812	0718910	4.4	0.1732	22	27	28	9	•	
L9812	0718926	4.5	0.1772					•	
L9812	0718932	4.6	0.1811					•	
L9812	0718949	4.7	0.1850	23	28	29	10	•	
L9813	1489640	3/16	0.1875					•	
L9812	0718955	4.8	0.1890					•	
L9812	0718961	4.9	0.1929	24	29	30	11	•	
L9812	0718978	5.0	0.1969					•	
L9812	0718984	5.1	0.2008					•	
L9812	0718990	5.2	0.2047	25	30	31	12	•	
L9812	0719005	5.3	0.2087					•	
L9812	0719011	5.4	0.2126					•	
L9812	0719028	5.5	0.2165	26	31	32	13	•	
L9813	1489656	7/32	0.2188					•	
L9812	0719034	5.6	0.2205					•	
L9812	0719040	5.7	0.2244	27	32	33	14	•	
L9812	0719057	5.8	0.2283					•	
L9812	0719063	5.9	0.2323					•	

List #	EDP #	Size	Decimal Equivalent	Flute Length ℓ	Overall Length L	L1	Shank Dia. Ds	Stock
L9812	0719070	6.0	0.2362	27	82	28	6	•
L9812	0719086	6.1	0.2402	28	88	31	7	•
L9812	0719092	6.2	0.2441					•
L9812	0719108	6.3	0.2480					•
L9813	1489662	1/4	0.2500	30	94	32	8	•
L9812	0719114	6.4	0.2520					•
L9812	0719120	6.5	0.2559					•
L9812	0719137	6.6	0.2598	31	100	33	9	•
L9812	0719143	6.7	0.2638					•
L9812	0719150	6.8	0.2677					•
L9812	0719166	6.9	0.2717	32	106	34	10	•
L9812	0719172	7.0	0.2756					•
L9812	0719189	7.1	0.2795					•
L9813	1489679	9/32	0.2812	33	112	35	11	•
L9812	0719195	7.2	0.2835					•
L9812	0719200	7.3	0.2874					•
L9812	0719217	7.4	0.2913	34	118	36	12	•
L9812	0719223	7.5	0.2953					•
L9812	0719230	7.6	0.2992					•
L9812	0719246	7.7	0.3031	36	124	37	13	•
L9812	0719252	7.8	0.3071					•
L9812	0719269	7.9	0.3110					•
L9813	1489685	5/16	0.3125	37	130	38	14	•
L9812	0719275	8.0	0.3150					•
L9812	0719281	8.1	0.3189					•
L9812	0719298	8.2	0.3228	39	136	39	15	•
L9812	0719303	8.3	0.3268					•
L9813	1489691	21/64	0.3281					•
L9812	0719310	8.4	0.3307	40	142	40	16	•
L9812	0719326	8.5	0.3346					•
L9812	0719332	8.6	0.3386					•
L9812	0719349	8.7	0.3425	41	148	41	17	•
L9812	0719355	8.8	0.3465					•
L9812	0719361	8.9	0.3504					•
L9812	0719378	9.0	0.3543	42	154	42	18	•
L9812	0719384	9.1	0.3583					•
L9813	1489707	23/64	0.3594					•
L9812	0719390	9.2	0.3622	43	160	43	19	•
L9812	0719406	9.3	0.3661					•
L9812	0719412	9.4	0.3701					•
L9812	0719429	9.5	0.3740	45	166	44	20	•
L9813	1489713	3/8	0.3750					•
L9812	0719435	9.6	0.3780					•
L9812	0719441	9.7	0.3819	46	172	45	21	•
L9812	0719458	9.8	0.3858					•
L9812	0719464	9.9	0.3898					•
L9812	0719470	10.0	0.3937	48	178	46	22	•
L9812	0719487	10.1	0.3976					•
L9812	0719493	10.2	0.4016					•
L9812	0719509	10.3	0.4055	49	184	47	23	•
L9813	1489720	13/32	0.4063					•
L9812	0719515	10.4	0.4094					•
L9812	0719521	10.5	0.4134	50	190	48	24	•
L9812	0719538	10.6	0.4173					•

* Package Qty: 1 per Tube Size

L9812 Metric Size
L9813 Fractional Size

List #	EDP #	Size	Decimal Equivalent	Flute Length	Overall Length	L1	Shank Dia.	Stock
		Dc		ℓ	L	L1	Ds	
L9812	0719544	10.7	0.4213					•
L9812	0719550	10.8	0.4252	49	116	51	11	•
L9812	0719567	10.9	0.4291					•
L9812	0719573	11.0	0.4331	50				•
L9812	0719580	11.1	0.4370					•
L9813	1489736	7/16	0.4375	51		53		•
L9812	0719596	11.2	0.4409					•
L9812	0719601	11.3	0.4449					•
L9812	0719618	11.4	0.4488					•
L9812	0719624	11.5	0.4528	52	122	54	12	•
L9813	1489742	29/64	0.4531					•
L9812	0719630	11.6	0.4567					•
L9812	0719647	11.7	0.4606			55		•
L9812	0719653	11.8	0.4646	54				•
L9812	0719660	11.9	0.4685					•

List #	EDP #	Size	Decimal Equivalent	Flute Length	Overall Length	L1	Shank Dia.	Stock
		Dc		ℓ	L	L1	Ds	
L9813	1489759	15/32	0.4688					•
L9812	0719676	12.0	0.4724	54	122	55	12	•
L9812	0719682	12.5	0.4921	57	128	59		•
L9813	1489765	1/2	0.5000	58	128	60	13	•
L9812	0719699	13.0	0.5118	59	128	60		•
L9812	0719704	13.5	0.5315	61	134	63		•
L9812	0719710	14.0	0.5512	63	134	64	14	•
L9813	1489771	9/16	0.5625	64	140	68		•
L9812	0719727	14.5	0.5709	66	140	68	15	•
L9812	0719733	15.0	0.5906	68	140	69		•
L9812	0719740	15.5	0.6102	70	146	72		•
L9813	1489788	5/8	0.6250	72	146	73	16	•
L9812	0719756	16.0	0.6299	72	146	73		•
L9813	1496964	11/16	0.6875	74	146	75	18	•
L9813	1496970	3/4	0.7500	76	152	77	20	•

* Package Qty: 1 per Tube Size

⚠ WARNING: Cancer - www.P65Warnings.ca.gov

Standard Drilling Conditions

LIST 9812, 9813

Work Material		Cast Irons / Carbon Steels		Alloy Steels (20-30 HRC)		Mold Steels (30-40 HRC)		Hardened Steels (40-50 HRC)		Ductile Cast Irons		Stainless Steel (300-Series Stainless)		Nickel Alloys, Titanium Alloys, PH Stainless		Aluminum Alloys		Aluminum Casting	
Speed (SFM)		160 - 200 SFM		130 - 170 SFM		95 - 140 SFM		80 - 100 SFM		130 - 165 SFM		95 - 135 SFM		70 - 80 SFM		180 - 200 SFM		160 - 185 SFM	
Metric mm	Decimal	RPM	Feed (IPR)	RPM	Feed (IPR)	RPM	Feed (IPR)	RPM	Feed (IPR)	RPM	Feed (IPR)	RPM	Feed (IPR)	RPM	Feed (IPR)	RPM	Feed (IPR)	RPM	Feed (IPR)
1	0.039	15900	0.0003	12700	0.0002	9550	0.0002	7960	0.0002	12700	0.0002	9550	0.0001	6850	0.0006	18400	0.0008	15610	0.0004
1.5	0.059	10600	0.0005	8490	0.0004	6370	0.0003	5320	0.0003	8490	0.0003	6370	0.0001	4600	0.0009	12300	0.0012	10430	0.0006
2	0.079	9550	0.0007	7960	0.0005	5570	0.0004	4790	0.0004	7960	0.0004	6370	0.0002	3900	0.0012	9200	0.0014	8890	0.0007
Speed (SFM)		390 - 395 SFM		245 - 330 SFM		225 - 245 SFM		145 - 165 SFM		245 - 330 SFM		175 - 195 SFM		80 - 100 SFM		450 - 550 SFM		360 - 455 SFM	
2.5	0.098	11500	0.002	9600	0.001	9500	0.001	5750	0.001	10600	0.001	7500	0.001	3300	0.002	19400	0.004	14000	0.002
3	0.118	12700	0.003	10600	0.002	7400	0.002	5300	0.002	10600	0.002	6000	0.003	3200	0.002	16200	0.005	14800	0.004
4	0.157	9500	0.004	7900	0.003	5550	0.002	4000	0.003	7900	0.002	4500	0.004	2400	0.003	12100	0.006	11100	0.005
5	0.197	7600	0.005	6300	0.004	4450	0.003	3200	0.004	6300	0.003	3600	0.005	1900	0.004	9700	0.008	8900	0.006
6	0.236	6300	0.006	5300	0.005	3700	0.004	2700	0.004	5300	0.004	3000	0.006	1600	0.005	8100	0.010	7400	0.007
8	0.315	4800	0.008	3950	0.006	2790	0.005	2000	0.006	3950	0.005	2250	0.008	1200	0.006	6050	0.011	5570	0.009
10	0.394	3800	0.010	3150	0.008	2230	0.006	1600	0.007	3150	0.006	1800	0.010	950	0.007	4850	0.013	4460	0.012
12	0.472	3200	0.012	2650	0.009	1860	0.007	1300	0.009	2650	0.007	1500	0.012	800	0.007	4050	0.016	3710	0.014
16	0.630	2400	0.016	1990	0.013	1390	0.009	1000	0.011	1990	0.009	1100	0.016	600	0.009	3050	0.018	2790	0.019

Note : 1) Adjust drilling conditions according to the rigidity of machine or work clamp state.
 2) Use the table values for drilling depths upto 5xD. Adjust cutting conditions per table based on "degree angle to be drilled."
 3) Above table values are for drilling water soluble cutting fluid. For non-water soluble cutting fluid reduce the RPM and feed rates by 20%
 4) Center Drill or Guide hole required. (1: Use AG Starting drill or Aqua Ex Flat drill 2: For drilling guide holes in Stainless use AQUA EX Flat OH3D)

Formulas : $RPM = \frac{SFM \times 3.82}{\text{Drill dia.}}$ Feed Rate (in/min) : RPM×IPR

Aqua Drill EX Flat Oil Hole 5D



• For entry on flat surfaces, Center Drill Hole is recommended

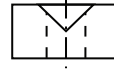

• Center Hole Diameter should be 0.5mm larger than Flat drill Diameter

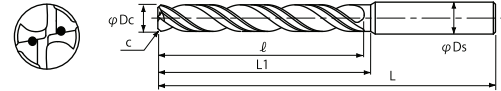

Drill Dia (in mm)		Corner Chamfer
Above	Up to	C (mm)
	6.0	0.04
6.0	10.0	0.1
10.0		0.2

L9814 / L9815

Metric Size / Fractional Size Including NEW MICRO Sizes!

List #	EDP #	Size	Decimal Equivalent	Flute Length <i>ℓ</i>	Overall Length		L1	Shank Dia. <i>Ds</i>	Stock
					L	L1			
L9814	0760528	1.0	0.0394	6.3	57	6.6			•
L9814	0760534	1.1	0.0433	6.9		7.2			•
L9814	0760540	1.2	0.0472	7.6		7.9			•
L9814	0760557	1.3	0.0512	8.2		8.5			•
L9814	0760563	1.4	0.0551	8.8		9.1			•
L9814	0760570	1.5	0.0591	9.5		9.8			•
L9814	0760586	1.6	0.0630	10.1		10.4			•
L9814	0760592	1.7	0.0669	10.7		11			•
L9814	0760608	1.8	0.0709	11.3		11.6			•
L9814	0760614	1.9	0.0748	12		12.3			•
L9814	0760620	2.0	0.0787	12.6		12.9			•
L9814	0760637	2.1	0.0827	13.2		13.5			•
L9814	0760643	2.2	0.0866	13.9		14.2			•
L9814	0760650	2.3	0.0906	14.5		14.8			•
L9814	0760666	2.4	0.0945	15.1		15.4			•
L9814	0760672	2.5	0.0984	15.8		16.1			•
L9814	0760689	2.6	0.1024	16.4		16.7			•
L9814	0760695	2.7	0.1063	17		17.3			•
L9814	0760700	2.8	0.1102	17.6		17.9			•
L9814	0760717	2.9	0.1142	18.3		18.6			•
L9814	0719762	3.0	0.1181	20	74	21			•
L9814	0719779	3.1	0.1220						•
L9815	1489794	1/8	0.1250						•
L9814	0719785	3.2	0.1260						•
L9814	0719791	3.3	0.1299						•
L9814	0719807	3.4	0.1339						•
L9814	0719813	3.5	0.1378						•
L9814	0719820	3.6	0.1417						•
L9814	0719836	3.7	0.1457						•
L9814	0719842	3.8	0.1496						•
L9814	0719859	3.9	0.1535						•
L9815	1489800	5/32	0.1563						•
L9814	0719865	4.0	0.1575						•
L9814	0719871	4.1	0.1614						•
L9814	0719888	4.2	0.1654						•
L9814	0719894	4.3	0.1693						•
L9814	0719900	4.4	0.1732						•
L9814	0719916	4.5	0.1772						•
L9814	0719922	4.6	0.1811						•
L9814	0719939	4.7	0.1850						•
L9815	1489816	3/16	0.1875						•
L9814	0719945	4.8	0.1890						•
L9814	0719951	4.9	0.1929						•
L9814	0719968	5.0	0.1969						•
L9814	0719974	5.1	0.2008						•
L9814	0719980	5.2	0.2047						•
L9814	0719997	5.3	0.2087						•
L9814	0720000	5.4	0.2126						•
L9814	0720017	5.5	0.2165						•
L9815	1489822	7/32	0.2188						•
L9814	0720023	5.6	0.2205						•
L9814	0720030	5.7	0.2244						•
L9814	0720046	5.8	0.2283						•
L9814	0720052	5.9	0.2323						•

List #	EDP #	Size	Decimal Equivalent	Flute Length <i>ℓ</i>	Overall Length		L1	Shank Dia. <i>Ds</i>	Stock
					L	L1			
L9814	0720069	6.0	0.2362						•
L9814	0720075	6.1	0.2402	41					•
L9814	0720081	6.2	0.2441						•
L9814	0720098	6.3	0.2480						•
L9815	1489839	1/4	0.2500						•
L9814	0720103	6.4	0.2520	43					•
L9814	0720110	6.5	0.2559						•
L9814	0720126	6.6	0.2598						•
L9814	0720132	6.7	0.2638						•
L9814	0720149	6.8	0.2677						•
L9814	0720155	6.9	0.2717						•
L9814	0720161	7.0	0.2756	46					•
L9814	0720178	7.1	0.2795						•
L9815	1489845	9/32	0.2812						•
L9814	0720184	7.2	0.2835						•
L9814	0720190	7.3	0.2874						•
L9814	0720206	7.4	0.2913						•
L9814	0720212	7.5	0.2953						•
L9814	0720229	7.6	0.2992						•
L9814	0720235	7.7	0.3031						•
L9814	0720241	7.8	0.3071						•
L9814	0720258	7.9	0.3110	52					•
L9815	1489851	5/16	0.3125						•
L9814	0720264	8.0	0.3150						•
L9814	0720270	8.1	0.3189						•
L9814	0720287	8.2	0.3228						•
L9814	0720293	8.3	0.3268						•
L9815	1489868	21/64	0.3281						•
L9814	0720309	8.4	0.3307						•
L9814	0720315	8.5	0.3346						•
L9814	0720321	8.6	0.3386						•
L9814	0720338	8.7	0.3425						•
L9814	0720344	8.8	0.3465						•
L9814	0720350	8.9	0.3504						•
L9814	0720367	9.0	0.3543						•
L9814	0720373	9.1	0.3583						•
L9815	1489874	23/64	0.3594						•
L9814	0720380	9.2	0.3622						•
L9814	0720396	9.3	0.3661						•
L9814	0720401	9.4	0.3701						•
L9814	0720418	9.5	0.3740						•
L9815	1489880	3/8	0.3750						•
L9814	0720424	9.6	0.3780						•
L9814	0720430	9.7	0.3819						•
L9814	0720447	9.8	0.3858						•
L9814	0720453	9.9	0.3898						•
L9814	0720460	10.0	0.3937						•
L9814	0720476	10.1	0.3976						•
L9814	0720482	10.2	0.4016						•
L9814	0720499	10.3	0.4055						•
L9815	1489897	13/32	0.4063						•
L9814	0720504	10.4	0.4094						•
L9814	0720510	10.5	0.4134						•
L9814	0720527	10.6	0.4173						•

* Package Qty: 1 per Tube Size

L9814 Metric Size
L9815 Fractional Size

List #	EDP #	Size	Decimal Equivalent	Flute Length	Overall Length	L1	Shank Dia.	Stock
		Dc		ℓ	L	L1	Ds	
L9814	0720533	10.7	0.4213					•
L9814	0720540	10.8	0.4252	72	138	73	11	•
L9814	0720556	10.9	0.4291					•
L9814	0720562	11.0	0.4331	73				•
L9814	0720579	11.1	0.4370					•
L9815	1489902	7/16	0.4375					•
L9814	0720585	11.2	0.4409	74		77		•
L9814	0720591	11.3	0.4449					•
L9814	0720607	11.4	0.4488					•
L9814	0720613	11.5	0.4528		146	78	12	•
L9815	1489919	29/64	0.4531					•
L9814	0720620	11.6	0.4567					•
L9814	0720636	11.7	0.4606			79		•
L9814	0720642	11.8	0.4646	78				•

* Package Qty: 1 per Tube Size

List #	EDP #	Size	Decimal Equivalent	Flute Length	Overall Length	L1	Shank Dia.	Stock
		Dc		ℓ	L	L1	Ds	
L9814	0720659	11.9	0.4685					•
L9815	1489925	15/32	0.4688	78	146	79	12	•
L9814	0720665	12.0	0.4724					•
L9814	0720671	12.5	0.4921	82		84		•
L9815	1489931	1/2	0.5000	85	153	86	13	•
L9814	0720688	13.0	0.5118	86		86		•
L9814	0720694	13.5	0.5315	89		91		•
L9814	0720700	14.0	0.5512	91	162	92	14	•
L9815	1489948	9/16	0.5625	93		97		•
L9814	0720716	14.5	0.5709	95	169	97	15	•
L9814	0720722	15.0	0.5906	98		98		•
L9814	0720739	15.5	0.6102	102		104		•
L9815	1489954	5/8	0.6250	104	178	105	16	•
L9814	0720745	16.0	0.6299	104		105		•

⚠ WARNING: Cancer - www.P65Warnings.ca.gov

Standard Drilling Conditions

LIST 9814, 9815

Work Material		Cast Irons / Carbon Steels		Alloy Steels (20-30 HRC)		Mold Steels (30-35 HRC)		Hardened Steels (40-50 HRC)		Ductile Cast Irons		Stainless Steel (300-Series Stainless)		Nickel Alloys, Titanium Alloys, PH Stainless		Aluminum Alloys		Aluminum Casting		
Speed (SFM)		115 - 140 SFM		90 - 115 SFM		65 - 80 SFM		55 - 70 SFM		90 - 115 SFM		65 - 95 SFM		70 - 80 SFM		180 - 200 SFM		160 - 185 SFM		
Metric	mm	Decimal	RPM	Feed (IPR)	RPM	Feed (IPR)	RPM	Feed (IPR)	RPM	Feed (IPR)	RPM	Feed (IPR)	RPM	Feed (IPR)	RPM	Feed (IPR)	RPM	Feed (IPR)	RPM	Feed (IPR)
1	0.039	11130	0.0003	8890	0.0002	6685	0.0002	5572	0.0002	8890	0.0002	6685	0.0001	6850	0.0006	18400	0.0008	15610	0.0004	
1.5	0.059	7420	0.0005	5943	0.0004	4459	0.0003	3724	0.0003	5943	0.0003	4459	0.0001	4600	0.0009	12300	0.0012	10430	0.0006	
2	0.079	6685	0.0007	5572	0.0005	3899	0.0004	3353	0.0004	5572	0.0004	4459	0.0002	3900	0.0012	9200	0.0014	8890	0.0007	
Speed (SFM)		295 - 395 SFM		245 - 330 SFM		225 - 245 SFM		145 - 165 SFM		245 - 330 SFM		185 - 195 SFM		80 - 95 SFM		450 - 550 SFM		360 - 455 SFM		
2.5	0.098	11500	0.002	9600	0.001	9500	0.001	5750	0.001	9560	0.001	7500	0.001	3300	0.002	19400	0.004	14000	0.002	
3	0.118	12700	0.003	10600	0.002	7400	0.002	5350	0.002	10600	0.002	6000	0.003	3000	0.002	16200	0.005	14800	0.004	
4	0.157	9000	0.004	7500	0.003	5200	0.002	3800	0.002	7900	0.002	4200	0.003	2200	0.002	12100	0.006	11100	0.005	
5	0.197	7200	0.005	5900	0.004	4200	0.003	3000	0.003	6300	0.003	3400	0.004	1800	0.003	9700	0.008	8900	0.006	
6	0.236	5900	0.006	5000	0.005	3500	0.003	2500	0.003	5300	0.004	2800	0.005	1500	0.004	8100	0.010	7400	0.007	
8	0.315	4500	0.008	3700	0.006	2600	0.005	1900	0.005	3950	0.005	2100	0.007	1100	0.005	6050	0.011	5570	0.009	
10	0.394	3600	0.010	2900	0.008	2100	0.006	1500	0.006	3150	0.006	1700	0.009	900	0.006	4850	0.013	4460	0.012	
12	0.472	3000	0.012	2500	0.009	1700	0.007	1200	0.007	2650	0.007	1400	0.010	700	0.007	4050	0.016	3710	0.014	
16	0.630	2200	0.016	1800	0.013	1300	0.009	900	0.010	1990	0.009	1000	0.014	500	0.009	3050	0.018	2790	0.019	

- Note: 1) Adjust drilling conditions according to the rigidity of machine or work clamp state.
 2) Use the table values for drilling depths upto 5xD. Adjust cutting conditions per table based on "degree angle to be drilled."
 3) Above table values are for drilling water soluble cutting fluid. For non-water soluble cutting fluid reduce the RPM and feed rates by 20%
 4) Center Drill or Guide hole required. (1: Use AG Starting drill or Aqua Ex Flat drill 2: For drilling guide holes in Stainless use AQUA EX Flat OH3D)

Formulas : $RPM = \frac{SFM \times 3.82}{\text{Drill dia.}}$ Feed Rate (in/min) : $RPM \times IPR$

Aqua Drill EX Flat Super Stub

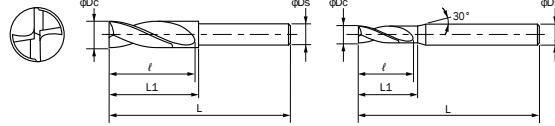

L9628 Metric Sizes

NEW
* Japan Stock Item

List #	EDP #	Size	Decimal Equivalent	Flute Length ℓ	Overall Length L	L1	Shank Dia. Ds	Stock
L9628	0765754	2.0	0.0787	7	50	7.8	4	•
L9628	0765760	2.1	0.0827	8		8.4		•
L9628	0765777	2.2	0.0866			8.4		•
L9628	0765783	2.3	0.0906	9		8.5		•
L9628	0765790	2.4	0.0945			9.6		•
L9628	0765805	2.5	0.0984	10		9.7		•
L9628	0765811	2.6	0.1024			9.8		•
L9628	0765828	2.7	0.1063	11		10.9		•
L9628	0765834	2.8	0.1102			11		•
L9628	0765840	2.9	0.1142	12		13		•
L9628	0765055	3.0	0.1181			11.4		•
L9628	0765061	3.1	0.1220	13		12.5		•
L9628	0765078	3.2	0.1260			12.6		•
L9628	0765084	3.3	0.1299	14	12.7	•		
L9628	0765090	3.4	0.1339		13.2	•		
L9628	0765106	3.5	0.1378	15	13.3	•		
L9628	0765112	3.6	0.1417		13.4	•		
L9628	0765129	3.7	0.1457	16	14	•		
L9628	0765135	3.8	0.1496		14.1	•		
L9628	0765141	3.9	0.1535	17	14.2	•		
L9628	0765158	4.0	0.1575		14.3	•		
L9628	0765164	4.1	0.1614	18	16.4	•		
L9628	0765170	4.2	0.1654		16.4	•		
L9628	0765187	4.3	0.1693	19	16.5	•		
L9628	0765193	4.4	0.1732		17.6	•		
L9628	0765209	4.5	0.1772	20	17.7	•		
L9628	0765215	4.6	0.1811		17.8	•		
L9628	0765221	4.7	0.1850	21	18.9	•		
L9628	0765238	4.8	0.1890		19	•		
L9628	0765244	4.9	0.1929	22	19	•		
L9628	0765250	5.0	0.1969		19.1	•		
L9628	0765267	5.1	0.2008	23	21.2	•		
L9628	0765273	5.2	0.2047		21.3	•		
L9628	0765280	5.3	0.2087	24	21.4	•		
L9628	0765296	5.4	0.2126		22.5	•		
L9628	0765301	5.5	0.2165	25	22.6	•		
L9628	0765318	5.6	0.2205		22.7	•		
L9628	0765324	5.7	0.2244	26	23.7	•		
L9628	0765330	5.8	0.2283		23.8	•		
L9628	0765347	5.9	0.2323	27	23.9	•		
L9628	0765353	6.0	0.2362		24	•		
L9628	0765360	6.1	0.2402	28	25	•		
L9628	0765376	6.2	0.2441			•		
L9628	0765382	6.3	0.2480	29	26	•		
L9628	0765399	6.4	0.2520			•		
L9628	0765404	6.5	0.2559	30	26	•		
L9628	0765410	6.6	0.2598			•		
L9628	0765427	6.7	0.2638	31	26	•		
L9628	0765433	6.8	0.2677			•		
L9628	0765440	6.9	0.2717	32	29	•		
L9628	0765456	7.0	0.2756			•		
L9628	0765462	7.1	0.2795	33	29	•		
L9628	0765479	7.2	0.2835			•		
L9628	0765485	7.3	0.2874	34	29	•		
L9628	0765491	7.4	0.2913			•		
L9628	0765507	7.5	0.2953	35	31	•		
L9628	0765513	7.6	0.2992			•		
L9628	0765520	7.7	0.3031	36	31	•		
L9628	0765536	7.8	0.3071			•		
L9628	0765542	7.9	0.3110	37	31	•		
L9628	0765559	8.0	0.3150			•		

List #	EDP #	Size	Decimal Equivalent	Flute Length ℓ	Overall Length L	L1	Shank Dia. Ds	Stock		
L9628	0765565	8.1	0.3189	29	80	32	8	•		
L9628	0765571	8.2	0.3228					30	33	•
L9628	0765588	8.3	0.3268							
L9628	0765594	8.4	0.3307					32	•	
L9628	0765600	8.5	0.3346							33
L9628	0765616	8.6	0.3386					34	•	
L9628	0765622	8.7	0.3425							35
L9628	0765639	8.8	0.3465					36	•	
L9628	0765645	8.9	0.3504							37
L9628	0765651	9.0	0.3543					38	•	
L9628	0765668	9.1	0.3583							39
L9628	0765674	9.2	0.3622					40	•	
L9628	0765680	9.3	0.3661							41
L9628	0764690	9.4	0.3701	42	•					
L9628	0764706	9.5	0.3740			43	•			
L9628	0764712	9.6	0.3780	44	•					
L9628	0764729	9.7	0.3819			45	•			
L9628	0764735	9.8	0.3858	46	•					
L9628	0764741	9.9	0.3898			47	•			
L9628	0764758	10.0	0.3937	48	•					
L9628	0764764	10.1	0.3976			49	•			
L9628	0764770	10.2	0.4016	50	•					
L9628	0764787	10.3	0.4055			51	•			
L9628	0764793	10.4	0.4094	52	•					
L9628	0764809	10.5	0.4134			53	•			
L9628	0764815	10.6	0.4173	54	•					
L9628	0764821	10.7	0.4213			55	•			
L9628	0764838	10.8	0.4252	56	•					
L9628	0764844	10.9	0.4291			57	•			
L9628	0764850	11.0	0.4331	58	•					
L9628	0764867	11.1	0.4370			59	•			
L9628	0764873	11.2	0.4409	60	•					
L9628	0764880	11.3	0.4449			61	•			
L9628	0764896	11.4	0.4488	62	•					
L9628	0764901	11.5	0.4528			63	•			
L9628	0764918	11.6	0.4567	64	•					
L9628	0764924	11.7	0.4606			65	•			
L9628	0764930	11.8	0.4646	66	•					
L9628	0764947	11.9	0.4685			67	•			
L9628	0764953	12.0	0.4724	68	•					
L9628	0764960	12.1	0.4764			69	•			
L9628	0764976	12.2	0.4803	70	•					
L9628	0764982	12.3	0.4843			71	•			
L9628	0764999	12.4	0.4882	72	•					
L9628	0765003	12.5	0.4921			73	•			
L9628	0765010	12.6	0.4961	74	•					
L9628	0765026	12.7	0.5000			75	•			
L9628	0765032	12.8	0.5039	76	•					
L9628	0765049	12.9	0.5079			77	•			
L9628	0764305	13.0	0.5118	78	•					
L9628	0764311	13.1	0.5157			79	•			
L9628	0764328	13.2	0.5197	80	•					
L9628	0764334	13.3	0.5236			81	•			
L9628	0764340	13.4	0.5276	82	•					
L9628	0764357	13.5	0.5315			83	•			
L9628	0764363	13.6	0.5354	84	•					
L9628	0764370	13.7	0.5394			85	•			
L9628	0764386	13.8	0.5433	86	•					
L9628	0764392	13.9	0.5472			87	•			
L9628	0764408	14.0	0.5512	88	•					
L9628	0764414	14.1	0.5551			50	105	53	•	

* Package Qty: 1 per Tube Size

L9628 Metric Size

*Japan Stock Item

List #	EDP #	Size	Decimal Equivalent	Flute Length	Overall Length	L1	Shank Dia.	Stock
		Dc		ℓ	L	L1	Ds	
L9628	0764420	14.2	0.5591	50	105	53	12	•
L9628	0764437	14.3	0.5630					•
L9628	0764443	14.4	0.5669					•
L9628	0764450	14.5	0.5709	51		54		•
L9628	0764466	14.6	0.5748					•
L9628	0764472	14.7	0.5787	52		115		57
L9628	0764489	14.8	0.5827		•			
L9628	0764495	14.9	0.5866		•			
L9628	0764500	15.0	0.5906	54	115		57	•
L9628	0764517	15.1	0.5945					•
L9628	0764523	15.2	0.5984					•
L9628	0764530	15.3	0.6024	55		115	57	•
L9628	0764546	15.4	0.6063					•
L9628	0764552	15.5	0.6102					•

List #	EDP #	Size	Decimal Equivalent	Flute Length	Overall Length	L1	Shank Dia.	Stock		
		Dc		ℓ	L	L1	Ds			
L9628	0764569	15.6	0.6142	55	115	57	12	•		
L9628	0764575	15.7	0.6181					•		
L9628	0764581	15.8	0.6220					•		
L9628	0764598	15.9	0.6260	56		59		16	•	
L9628	0764603	16.0	0.6299						•	
L9628	0764610	16.5	0.6496	58		125		61	16	•
L9628	0764626	17.0	0.6693		59		62			•
L9628	0764632	17.5	0.6890		61		63			•
L9628	0764649	18.0	0.7087	63	66		135	20		•
L9628	0764655	18.5	0.7283							65
L9628	0764661	19.0	0.7480	66	68		145	20		•
L9628	0764678	19.5	0.7677			68			71	•
L9628	0764684	20.0	0.7874	70	73	•				

* Package Qty: 1 per Tube Size

⚠ WARNING: Cancer - www.P65Warnings.ca.gov

Standard Drilling Conditions

LIST 9628

Work Material			Cast Irons / Carbon Steels		Alloy Steels (20-30 HRC)		Mold Steels/ Hardened Steels (30-35 HRC)		Ductile Cast Irons		Aluminum Alloys		Aluminum Casting	
Speed (SFM)			325-328 SFM		290-295 SFM		220-225 SFM		290-295 SFM		515-525 SFM		260-400 SFM	
Drill Diameter			RPM	Feed (IPR)	RPM	Feed (IPR)	RPM	Feed (IPR)	RPM	Feed (IPR)	RPM	Feed (IPR)	RPM	Feed (IPR)
Metric	mm	Decimal												
0.2	0.007		32000	0.0001	29000	0.0001	14000	0.0001	29000	0.0001	32000	0.0002	32000	0.0001
0.5	0.019		25500	0.0001	21000	0.0001	10000	0.0001	21000	0.0001	29000	0.0004	25500	0.0033
1	0.039		19000	0.0006	15900	0.0006	6400	0.0003	15900	0.0005	24000	0.0012	19000	0.0008
2	0.078		12000	0.0009	11500	0.0009	3200	0.0007	11500	0.0009	21000	0.0016	14500	0.0013
3	0.118		7950	0.0020	6900	0.0020	3700	0.0020	6900	0.0015	17000	0.0025	12500	0.0020
4	0.157		5950	0.0025	5150	0.0025	2800	0.0025	5150	0.0025	12500	0.0030	9550	0.0025
5	0.197		4800	0.0035	4150	0.0035	2200	0.0030	4100	0.0030	10000	0.0040	7650	0.0035
6	0.236		4000	0.0040	3450	0.0040	1800	0.0035	3450	0.0035	8500	0.0045	6400	0.0040
8	0.315		3000	0.0055	2600	0.0055	1400	0.0050	2600	0.0045	6350	0.0065	4750	0.0055
10	0.394		2400	0.0070	2050	0.0070	1100	0.0060	2050	0.0060	5100	0.0080	3800	0.0070
12	0.472		2000	0.0085	1700	0.0085	950	0.0070	1700	0.0070	4250	0.0095	3200	0.0080
16	0.630		1500	0.0110	1300	0.0110	700	0.0095	1300	0.0095	3200	0.0125	2400	0.0110
20	0.787		1200	0.0140	1050	0.0135	550	0.0120	1050	0.0115	2550	0.0155	1900	0.0135

Note: 1) Adjust drilling conditions according to the rigidity of machine or work clamp state.

2) Use the table values for drilling depths upto 2xD. Adjust cutting conditions per table based on "degree angle to be drilled."

3) Above table values are for drilling water soluble cutting fluid. For non-water soluble cutting fluid reduce the RPM and feed rates by 20%

4) Not recommended for drilling in Stainless Steel. We recommend using List9814 AQUA EX Flat OH3Dor OH5D for Stainless Steel & Hi-temp alloys.

5) Center Drill or Guide hole required. (1: Use AG Starting drill or Aqua Ex Flat drill)

Formulas : $RPM = \frac{SFM \times 3.82}{\text{Drill dia.}}$ Feed Rate (in/min) : $RPM \times IPR$

Aqua Drill EX Starting Drill

For use with Aqua Flat Drills (List 9819, 9817, 9815)

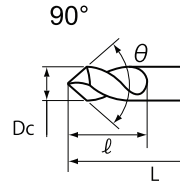

List 9624

NEW

Item Code	Size	Decimal Equivalent	Drill Point Angle	Flute Length	Overall Length	Shank Dia
EDP	Dc		90°	l	L	Ds
0727355	3.0	0.1181		9	48	3.0
0727360	4.0	0.1575		12	52	4.0
0727378	5.0	0.1969		14	60	5.0
0727384	6.0	0.2362		15	66	6.0
0727390	8.0	0.3150		20	79	8.0
0727406	10.0	0.3937		25	89	10.0
0727412	12.0	0.4724		30	102	12.0
0727429	16.0	0.6299		35	115	16.0
0727435	20.0	0.7874		40	131	20.0

Package Qty: 1 per Tube Size

WARNING: Cancer - www.P65Warnings.ca.gov

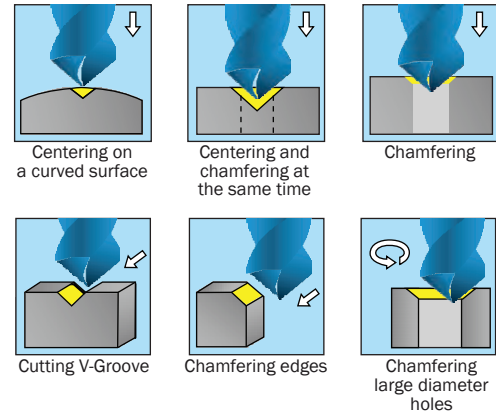

Standard Drilling Conditions

Centering

Work Material		Carbon Steels / Cast Irons <20 HRC		Alloy Steels 20 ~ 30 HRC		Mold Steels 30 ~ 40 HRC		Hardened Steel 40 ~ 50 HRC		Stainless Steel 300 /Series		Aluminum Alloy Copper Alloy	
Drill Diameter		RPM	Feed (IPM)	RPM	Feed (IPM)	RPM	Feed (IPM)	RPM	Feed (IPM)	RPM	Feed (IPM)	RPM	Feed (IPM)
Metric mm	Decimal												
3	0.118	7400	17.7	4800	11.4	2100	3.7	1900	2.8	2650	5.1	10600	43.3
4	0.157	5600	16.9	3600	10.2	1600	3.3	1450	2.6	2000	4.3	7950	41.3
5	0.197	4450	15.0	2850	9.4	1250	3.0	1150	2.4	1600	3.9	6350	37.4
6	0.236	3700	15.0	2400	9.4	1050	3.0	950	2.4	1300	3.9	5300	37.4
8	0.315	2800	15.0	1800	9.4	800	3.0	700	2.4	1000	3.9	4000	37.4
10	0.394	2200	13.0	1450	8.7	650	2.8	550	2.2	800	3.7	3200	31.5
12	0.472	1850	13.0	1200	8.7	530	2.8	480	2.2	650	3.7	2650	31.5
16	0.630	1400	11.4	900	7.5	400	2.6	350	2.0	500	3.5	2000	27.6
20	0.787	1100	10.2	720	6.7	320	2.6	280	2.0	400	3.1	1600	25.6

- Note : 1) Adjust drilling conditions according to the rigidity of machine or work clamp state.
 2) Above table values are for drilling water soluble cutting fluid. For non-water soluble cutting fluid reduce the RPM and feed rates by 20%
 3) Apply sufficient cutting fluid to work area.
 4) Use these cutting conditions for centering work.
 5) Reduce RPM and feed rates by 20% for centering work on rolled steel or forged surfaces, curved or angled surfaces.
 4) Use collet chucks or milling chucks.

Chamfering

Work Material		Carbon Steels / Cast Irons <20 HRC		Alloy Steels 20 ~ 30 HRC		Mold Steels/ Hardened Steels 30 ~ 40 HRC		Hardened Steel 40 ~ 50 HRC		Stainless Steel 300 /Series		Aluminum Alloy Copper Alloy	
Drill Diameter		RPM	Feed (IPM)	RPM	Feed (IPM)	RPM	Feed (IPM)	RPM	Feed (IPM)	RPM	Feed (IPM)	RPM	Feed (IPM)
Metric mm	Decimal												
3	0.118	7400	14.2	4800	9.1	2100	2.6	1900	2.0	2650	3.9	10600	35.0
4	0.157	5600	13.4	3600	8.3	1600	2.4	1450	1.8	2000	3.3	7950	33.1
5	0.197	4450	11.8	2850	7.5	1250	2.2	1150	1.6	1600	3.1	6350	29.9
6	0.236	3700	11.8	2400	7.5	1050	2.2	950	1.6	1300	3.1	5300	29.9
8	0.315	2800	11.8	1800	7.5	800	2.2	700	1.6	1000	3.1	4000	29.9
10	0.394	2200	10.2	1450	6.9	650	2.0	550	1.4	800	3.0	3200	25.2
12	0.472	1850	10.2	1200	6.9	530	2.0	480	1.4	650	3.0	2650	25.2
16	0.630	1400	9.1	900	5.9	400	1.8	350	1.2	500	2.8	2000	22.0
20	0.787	1100	8.3	720	5.3	320	1.8	280	1.2	400	2.4	1600	20.1

- Note : 1) Adjust drilling conditions according to the rigidity of machine or work clamp state.
 2) Above table values are for drilling water soluble cutting fluid. For non-water soluble cutting fluid reduce the RPM and feed rates by 20%
 3) Apply sufficient cutting fluid to work area.
 4) Use these cutting conditions for chamfering.
 5) Reduce RPM and feed rates at the same ratio if chattering occurs, because the workpiece is not rigidly mounted to the machine.
 4) Use collet chucks or milling chucks.

AG Starting Drill



For use with Aqua Flat Drills (List 9819, 9817, 9815)

List 6502

90° Range 3.0 to 20.0

140° Range 3.0 to 20.0

Item Code	Size	Decimal Equivalent	Drill Point Angle	Flute Length	Overall Length	Shank Dia
EDP	Dc			ℓ	L	Ds
0710358	3.0	0.1181	90°	9	48	3.0
0710364	4.0	0.1575		12	52	4.0
0712613	5.0	0.1969		14	60	5.0
0710370	6.0	0.2362		15	66	6.0
0710387	8.0	0.3150		20	79	8.0
0710393	10.0	0.3937		25	89	10.0
0710409	12.0	0.4724		30	102	12.0
0710415	16.0	0.6299		35	115	16.0
0710421	20.0	0.7874	40	131	20.0	
0710518	3.0	0.1181	140°	9	48	3.0
0710524	4.0	0.1575		12	52	4.0
0712636	5.0	0.1969		14	60	5.0
0710530	6.0	0.2362		15	66	6.0
0710547	8.0	0.3150		20	79	8.0
0710553	10.0	0.3937		25	89	10.0
0710560	12.0	0.4724		30	102	12.0
0710576	16.0	0.6299		35	115	16.0
0710582	20.0	0.7874	40	131	20.0	

Package Qty: 1 per Tube Size ⚠ WARNING: Cancer - www.P65Warnings.ca.gov

AG Starting Drill Extended Length



For use with Aqua Flat Drills (List 9819, 9817, 9815)

List 6504

90° Range 3.0 to 12.0

140° Range 3.0 to 12.0

Item Code	Size	Decimal Equivalent	Drill Point Angle	Flute Length	Overall Length	Shank Dia
EDP	Dc			ℓ	L	Ds
0710656	3.0	0.1181	90°	9	75	3.0
0710662	4.0	0.1575		12	100	4.0
0712659	5.0	0.1969		14	100	5.0
0710679	6.0	0.2362		15	150	6.0
0710685	8.0	0.3150		20	150	8.0
0710691	10.0	0.3937		25	200	10.0
0710707	12.0	0.4724		30	200	12.0
0710771	3.0	0.1181	140°	9	75	3.0
0710788	4.0	0.1575		12	100	4.0
0712671	5.0	0.1969		14	100	5.0
0710794	6.0	0.2362		15	150	6.0
0710800	8.0	0.3150		20	150	8.0
0710816	10.0	0.3937		25	200	10.0
0710822	12.0	0.4724		30	200	12.0

⚠ WARNING: Cancer - www.P65Warnings.ca.gov

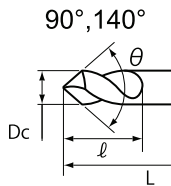

AREAS OF APPLICATION FOR AG STARTING

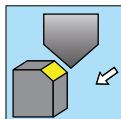
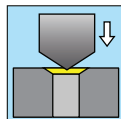
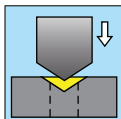
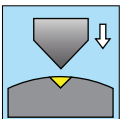

For Pre-Drilling of Drills that have inconsistent bite and drilling holes on curved or inclined surfaces

For Chamfering of Holes and Chamfering Edges

Usage Guide

AQDEXZ/AQDEXZOH3D

AQDEXZ/AQDEXZOH3D hole distension and vibration countermeasures



- For flat surfaces, drill a guide hole in very small steps (G73).
- For sloped surfaces, reduce the feed.

- If chamfering larger than the diameter of the hole is needed, such as for tap holes, do the chamfering first.

AQDEXZR/AQDEXZLS/AQDEXZOH5D

Using AQDEXZR/AQDEXZLS/AQDEXZOH5D

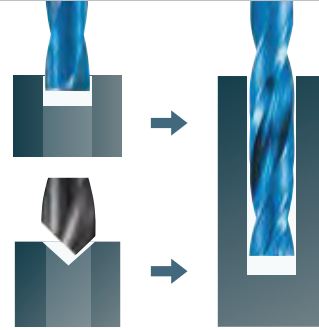

- Guide hole drilling with AQDEXZ.
- In case of stainless steels, use the AQDEXZOH3D.

- Chamfering with AGSTD.

Angled surface drilling and drilling conditions

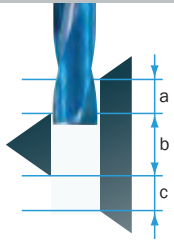

- a: Reduce drilling and feed speeds.
- b: Standard drilling conditions.
- c: Same as 'a', or reduce feed speed.

- Guide hole drilling with AQDEXZ.
- In case of stainless steels, use the AQDEXZOH3D.

AQDEXZ - Drilling Conditions

Comparison of angled surface drilling conditions with the AQDEXZ

Position No.	Angle	Cutting Speed			Feed & Speed		
		m/min	min ⁻¹	Ratio	mm/min	mm/rev	Ratio
①	0	75	2400	100%	420	0.18	100%
②	19°				210	0.09	50%
③	35°	52	1650	70%	120	0.07	40%
④	51°				120	0.07	40%
⑤	64°				90	0.06	33%
⑥	Halved				60	0.04	20%

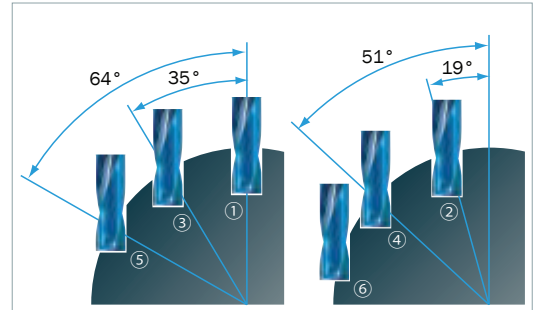

AQDEXZ1000 (φ10) / Work Material S45C / Depth 15mm / Water Soluble Cutting Fluid

AQDEXZ - Processing Examples

Slant hole in the entrance and exit

1050
Automotive Compact Pump Component

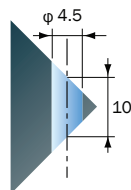

Before Improvement	After Improvement
Counterbore: Carbide Endmill	Aqua EX Flat
Drilling: Carbide Drill	One Step Drilling
High Tool Cost \$8800/month	\$4300/month
Large difference between entrance & exit holes: Max. 60 mm	Max 45 mm
Burred exit hole	Controls Burr

Cutting Conditions	
4.5mm (0.177")	Tool Dia.
60m/min (195 SFM)	Speed/SFM
480mm/min	Feed Rate
0.11mm/rev (0.004 IPR)	Depth
10mm (0.3937")	Coolant
Water Soluble	

Before tapping

1050
Electrical Components

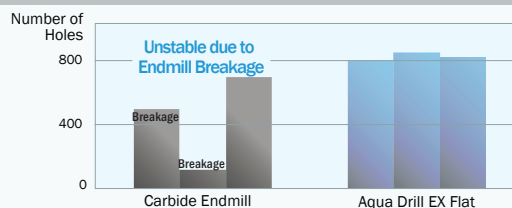
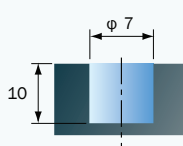

Cutting Conditions	
7mm (0.2756")	Tool Dia.
60m/min (195 SFM)	Speed/SFM
150mm/min	Feed Rate
0.06mm/rev (0.002 IPR)	Depth
10mm (0.3937")	Coolant
Water Soluble	

AQDEXZ - Drilling Examples

Slant Hole Single Process

316L Stainless Steel
Precision Parts

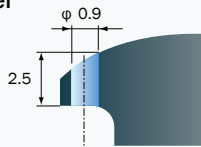

Before Improvement	After Improvement
Center Hole Drilling ↓ Drilling ↓ Form Drilling	Form Drilling ↓ Aqua EX Flat Reduces drilling by using special parts of different diameters

Cutting Conditions	
0.9mm (0.0354")	Tool Dia.
11m/min (40 SFM)	Speed/SFM
25mm/min	Feed Rate
0.01mm/rev (0.0002 IPR)	Depth
2.5mm (0.0984")	Coolant
Water Soluble	

Single Process / Less Burr

1045
Hydraulic Valve Parts

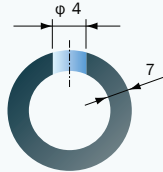

Before Improvement	After Improvement
Pre-Drilling: Carbide Endmill ↓ Drilling: Carbide Drill ↓ Burr Removal ↓ Burr	Aqua EX Flat One Step Drilling Reduces drilling, controls inner burr & reduces burr removal process with same efficiency & tool life

Cutting Conditions	
4.0mm (0.1574")	Tool Dia.
23m/min (75 SFM)	Speed/SFM
70mm/min	Feed Rate
0.04mm/rev (0.002 IPR)	Depth
7mm (0.275")	Coolant
Water Soluble	

Counter Boring

Copper Cast
Electronic parts

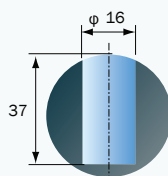

Before Improvement	After Improvement
Counter Boring: HSS Endmill ↓ Drilling: Carbide Drill ↓ Bottom Drilling: HSS Endmill	Aqua EX Flat One Step Drilling Allows drilling of copper alloys; reduces drilling

Cutting Conditions	
16.0mm (0.6299")	Tool Dia.
60m/min (200 SFM)	Speed/SFM
200mm/min	Feed Rate
0.17mm/rev (0.007 IPR)	Depth
37mm (1.45")	Coolant
Water Soluble	

Slant Hole Single Process

450 Nodular Cast Iron
Steering Parts

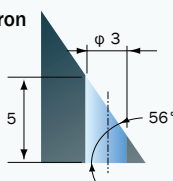

Before Improvement	After Improvement
Pre-Drilling: Carbide Endmill ↓ Drilling: Carbide Drill	Aqua EX Flat One Step Drilling Reduces drilling; Cuts tool cost

Cutting Conditions	
3.0mm (0.1181")	Tool Dia.
47m/min (155 SFM)	Speed/SFM
88mm/min	Feed Rate
0.18mm/rev (0.001 IPR)	Depth
5mm (0.196")	Coolant
Water Soluble	

Single Process of Thin Plate

Hastelloy
Heat-Resistant
Alloy Parts

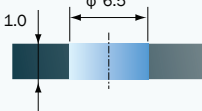

Before Improvement	After Improvement
Drilling ↓ End Mill Drilling	Aqua EX Flat One Step Drilling

Cutting Conditions	
6.5mm (0.256")	Tool Dia.
20m/min (67 SFM)	Speed/SFM
59mm/min	Feed Rate
0.06mm/rev (0.002 IPR)	Depth
1.0mm (0.039")	Coolant
Water Soluble	

Intersected Hole

1045
Hydraulic
Pump Parts

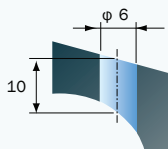

Before Improvement	After Improvement
Counter Boring: Carbide Endmill ↓ Drilling: Carbide Drill Difficult to remove burr under intersected hole	Aqua EX Flat One Step Drilling Controls back burr; Reduces drilling

Cutting Conditions	
6.0mm (0.2362")	Tool Dia.
68m/min (223 SFM)	Speed/SFM
250mm/min	Feed Rate
0.07mm/rev (0.003 IPR)	Depth
10mm (0.3937")	Coolant
Water Soluble	

NACHI



WARNING: This product can expose you to chemicals including cobalt, which is known to the State of California to cause cancer. For more information go to www.P65Warnings.ca.gov

NACHI AMERICA INC.

715 Pushville Road, Greenwood, Indiana, 46143, U.S.A.
Phone: 317-530-1003 Toll Free Phone: +1-888-340-8665
Fax: 317-530-1013 Toll Free Fax: +1-888-383-8665
NachiAmerica.com

NACHI CANADA INC.

89 Courtland Ave., Unit No.2, Concord, Ontario, L4K 3T4, CANADA
Phone: (905)-660-0088 Toll Free Phone: +1-800-387-9188
Fax: (905)-660-0097

NACHI MEXICANA, S.A. DE C.V.

Calle Tequisquiapan 2, Aerotech Industrial Park, Localidad Galeras, Municipio de Colon, Queretaro, Mexico C.P. 76295
Phone: +52-442-153-2424

12652 E. Alondra Blvd. Cerritos, California, 90703, U.S.A.
Phone: 562-802-0055 Toll Free Phone: 1-800-548-3903
Fax: 562-802-2455

2315 NW 107th Ave., Miami, Florida, 33172
Phone: 305-591-0054
Fax: 305-591-3110